

Specifications

Nominal Voltage	12V	
Rated capacity (10 hour rate)	65Ah	
Dimensions	Length	350±2mm(13.78inch)
	Width	166±2mm(5.54inch)
	Height	179±2mm(7.05inch)
	Total Height	179±2mm(7.05inch)
Approx. Weight	21kg(46.3lbs)±3%	

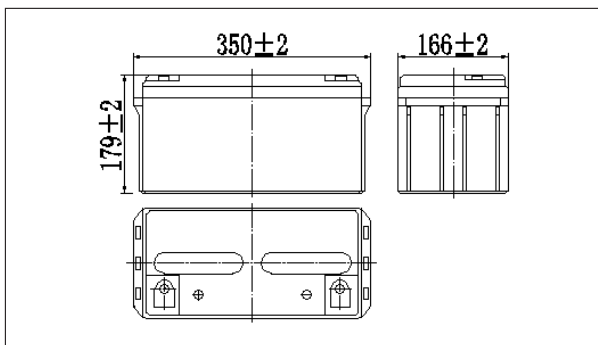

Outer dimensions (mm)



Terminal Type (mm)

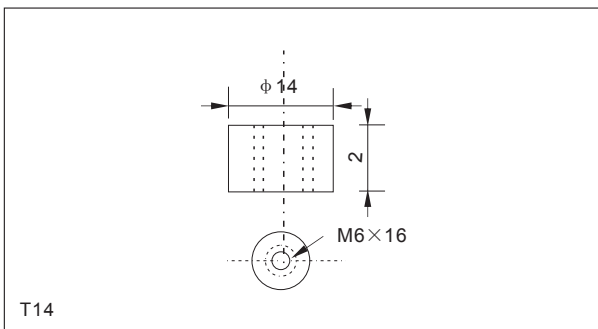

Characteristics

Capacity (25°C)	10HR(10.8V)	65Ah
	3HR(10.8V)	48Ah
	1HR(10.5V)	36Ah
Terminal type		T14
Internal resistance (Fully charged, 25°C)		Approx. 7m Ω
Capacity affected by temperature (10HR)	40°C	102%
	25°C	100%
	0°C	85%
	-15°C	65%
Self-discharge (25°C)	3 months	Remaining Capacity: 91%
	6 months	Remaining Capacity: 82%
	12 months	Remaining Capacity: 65%
Nominal operating temperature		25°C ± 3°C (77°F ± 5°F)
Operating temperature range	Discharge	-20°C ~ 50°C
	Charge	0°C ~ 45°C
	Storage	-20°C ~ 50°C
Float charging voltage(25°C)		13.50 to 13.80V Temperature compensation: -18mV/°C
Cyclic charging voltage(25°C)		14.50 to 14.70V Temperature compensation: -30mV/°C
Maximum charging current		13A
Maximum discharge current		650A(5 sec.)
Designed floating life(20°C)		12years

Construction

Component	Positive plate	Negative plate	Container	Cover	Separator	Electrolyte	Safety valve	Terminal
Raw material	Lead dioxide	Lead	ABS	ABS	AGM	Gel	Rubber	Copper

Constant Current Discharge Characteristics Unit:A(25°C, 77°F)

F.V/Time	10min	15min	30min	60min	2h	3h	4h	5h	8h	10h	20h
9.60V	127	104	63.1	39.0	23.8	16.9	13.3	11.3	7.96	6.62	3.51
9.90V	123	102	61.8	38.4	23.6	16.8	13.2	11.2	7.91	6.60	3.50
10.2V	118	97.8	59.9	37.4	23.4	16.7	13.1	11.1	7.85	6.58	3.49
10.5V	113	94.4	58.4	36.3	23.0	16.6	13.0	11.1	7.80	6.55	3.47
10.8V	106	89.4	56.3	35.1	22.5	16.2	12.6	10.7	7.57	6.50	3.45

Constant Power Discharge Characteristics Unit:W(25°C, 77°F)

F.V/Time	10min	15min	30min	60min	2h	3h	4h	5h	8h	10h	20h
9.60V	1369	1142	707	445	275	199	156	133	94.5	79.0	42.1
9.90V	1328	1115	693	438	273	198	155	132	94.0	78.9	42.0
10.2V	1273	1073	672	427	271	196	154	132	93.3	78.6	41.9
10.5V	1218	1037	656	413	267	195	153	131	92.7	78.2	41.6
10.8V	1150	982	632	400	260	191	148	124	89.9	77.6	41.3

Note: The above characteristics data can be obtained within three charge or discharge cycles.

Discharge characteristics(25°C)

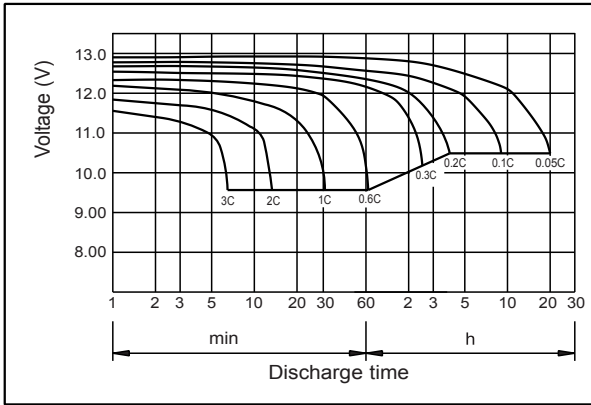

Charging characteristics (25°C)

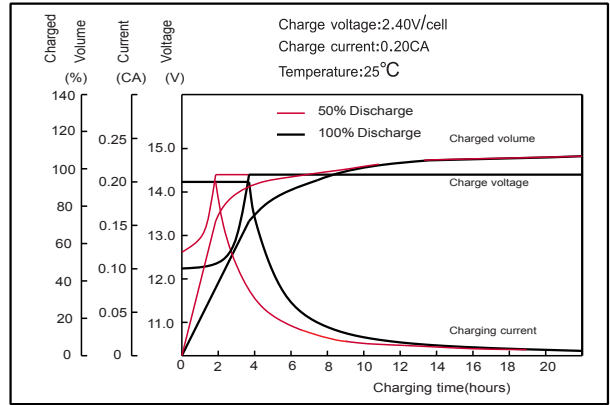

Temperature effects on Capacity

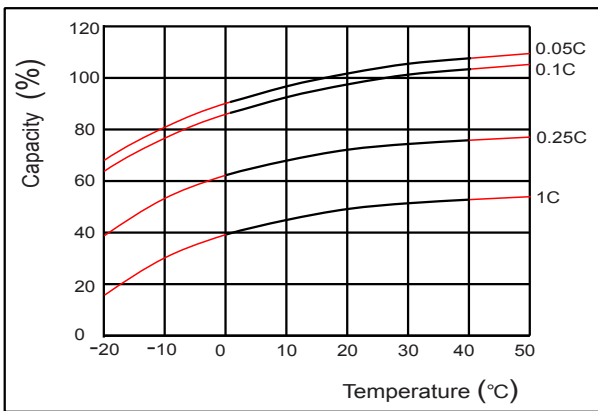

Self-discharge characteristics

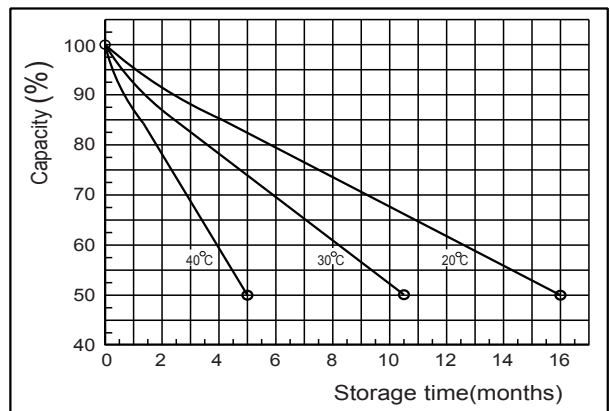

Floating life on Temperature

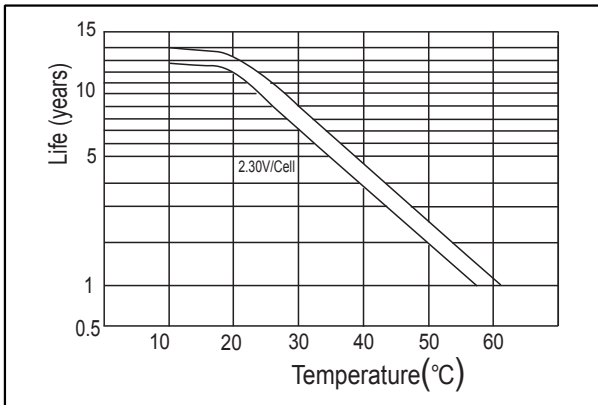

Cycle life on D.O.D (25°C)

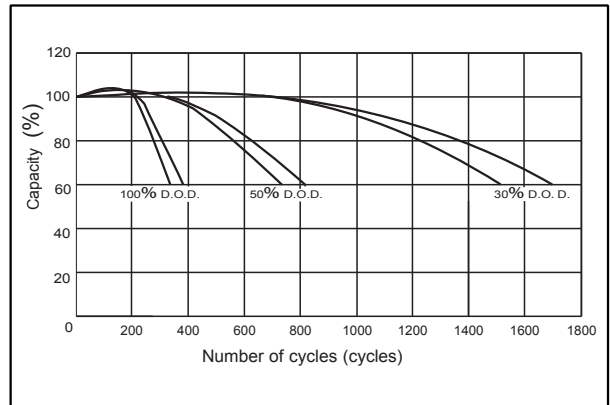

The relationship for OCV and Capacity (25°C)

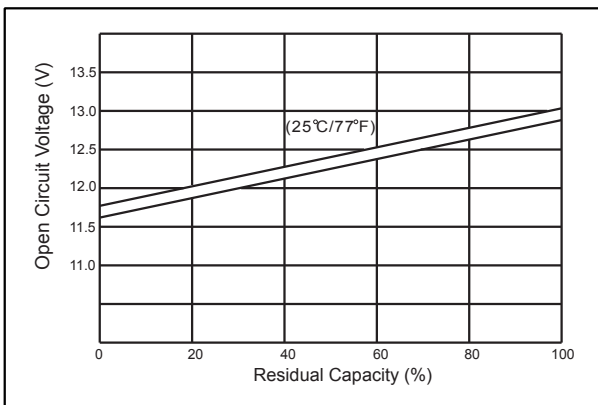

The relationship for Charging voltage and Temperature

