

1 **UPS Solar 25-60 180**



UPS Solar

- * : 1
- * : 2
- * : 3
- * : 4
- * : 5
- * : 6

UPS Solar

:
 :
 : 2 .. 110 °C
 : 60 °C
 : 983.2 / ³

TF : 110
 : CE,EAC

EN-JL1030
 ASTM 30 B
 , PES/PP

:
 : 0 .. 40 °C
 : 95 %
 : 10
 : G 11/2
 : 180

C	- :	2.5
	-P1:	65 .. 80
		2: 65
	:	80
	:	50 Hz
	:	1 x 230 V
	2:	0.28 A
	3:	0.34 A
		: 0.28 .. 0.34 A
	- :	2.5
	(IEC 34-5):	X2D
	(IEC 85):	H
	:	
	:	2.6
	:	2.8
	:	0.004 ³
VVS No.:		VVS NO 38 0591.061

UPS Solar 25-60 180 50

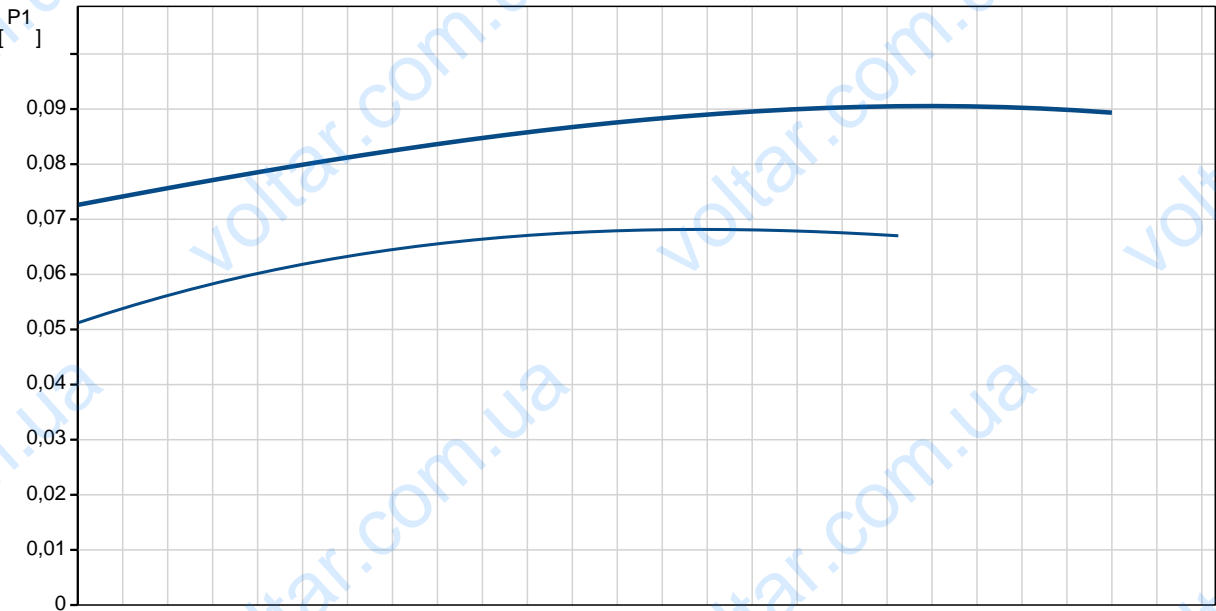
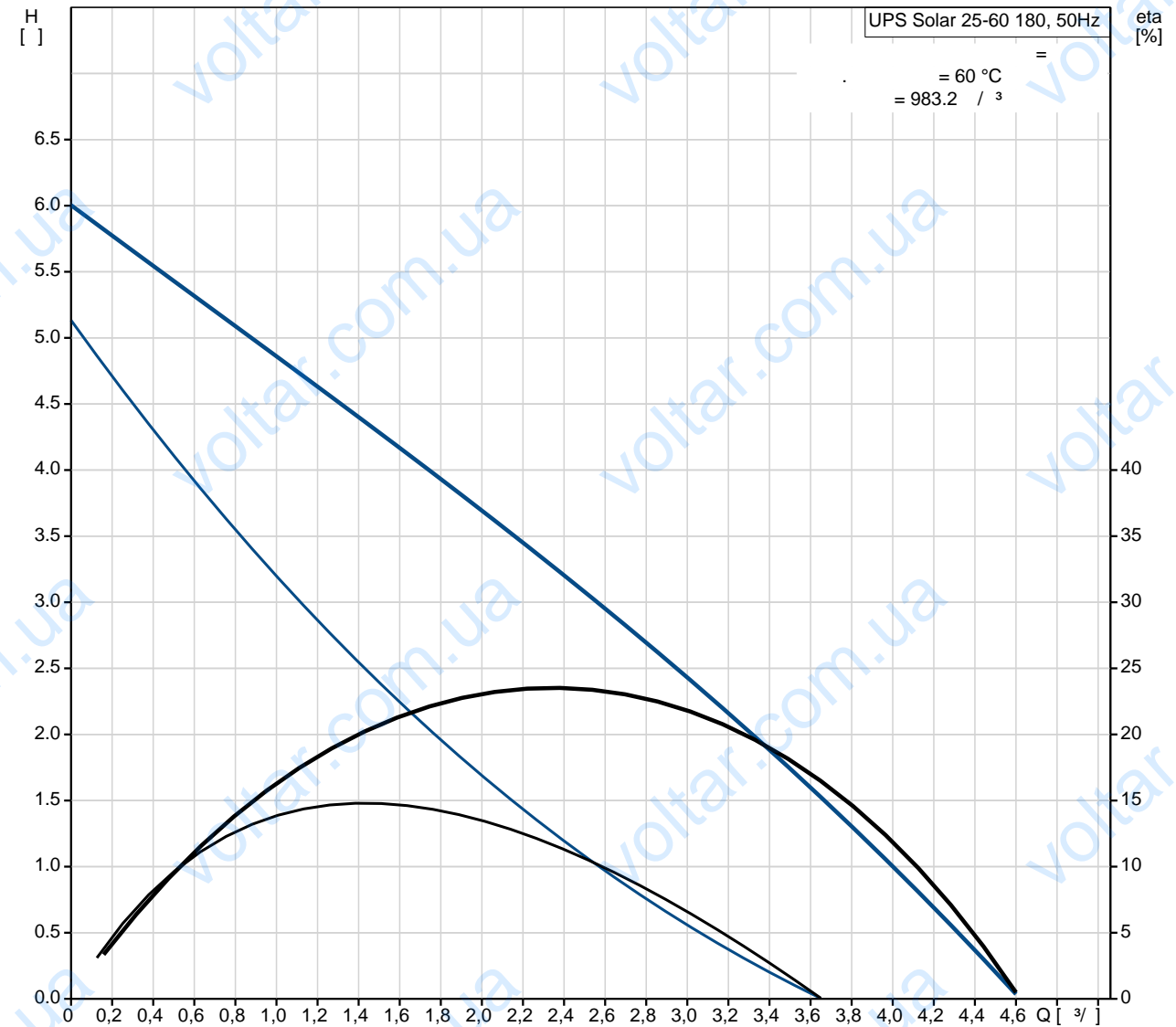

UPS Solar 25-60 180	
EAN	
TF	2 60 110 CE, EAC
	EN-JL1030 ASTM 30 B , PES/PP
	0 .. 40 °C
	95 %
	10
	G 1 1/2
	180
	2 .. 110 °C
	60 °C
	983.2 / ³
C	2.5
-P1:	65 .. 80
2:	65
	80
	50 Hz
	1 x 230 V
2:	0.28 A
3:	0.34 A
	0.28 .. 0.34 A
	2.5
(IEC 34-5):	X2D
(IEC 85):	H
	9H
	2.6
	2.8
	0.004 ³
VVS No.:	VVS NO 38 0591.061

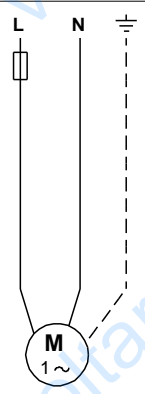
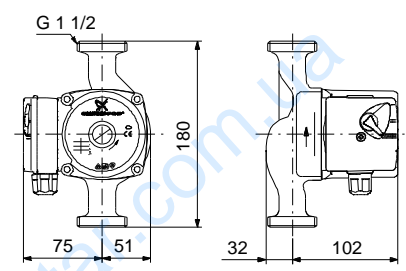
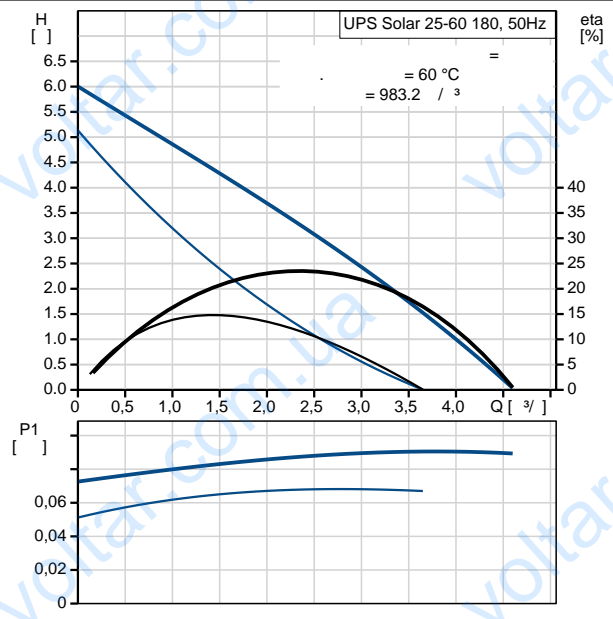

UPS Solar 25-60 180 50

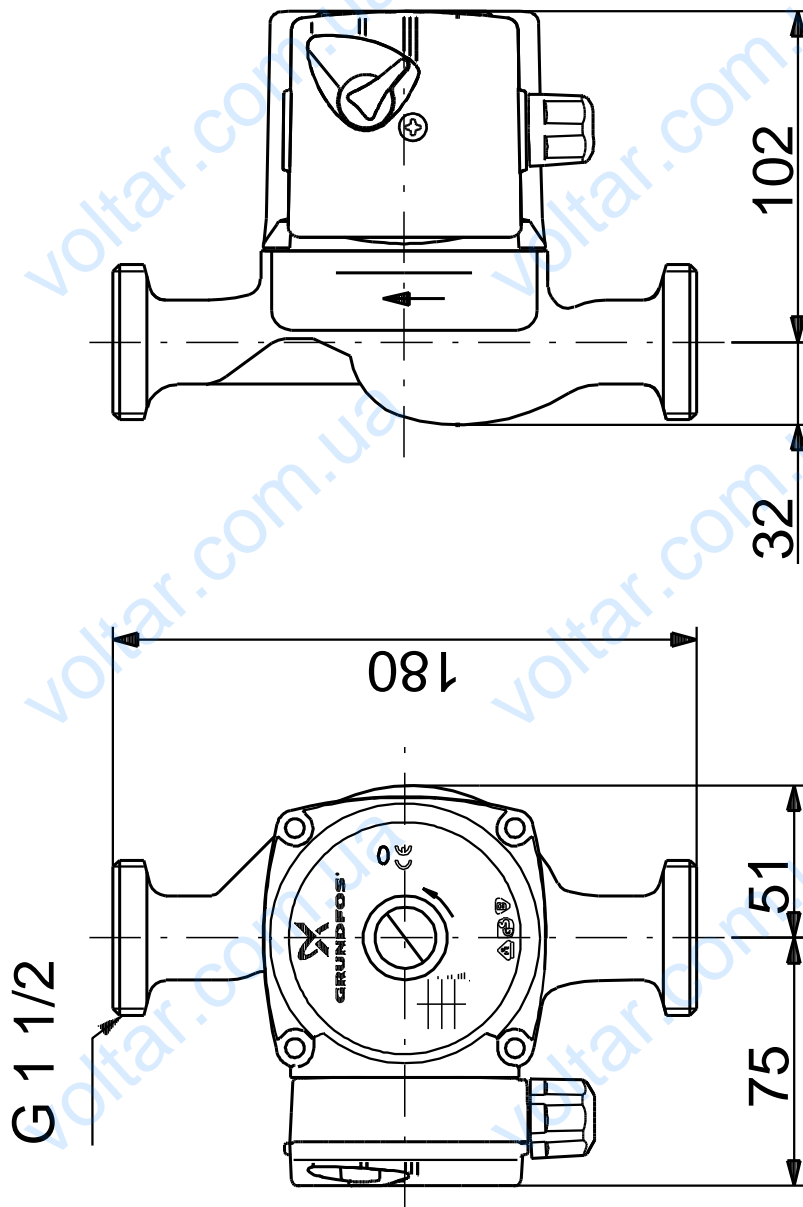

UPS Solar 25-60 180 50

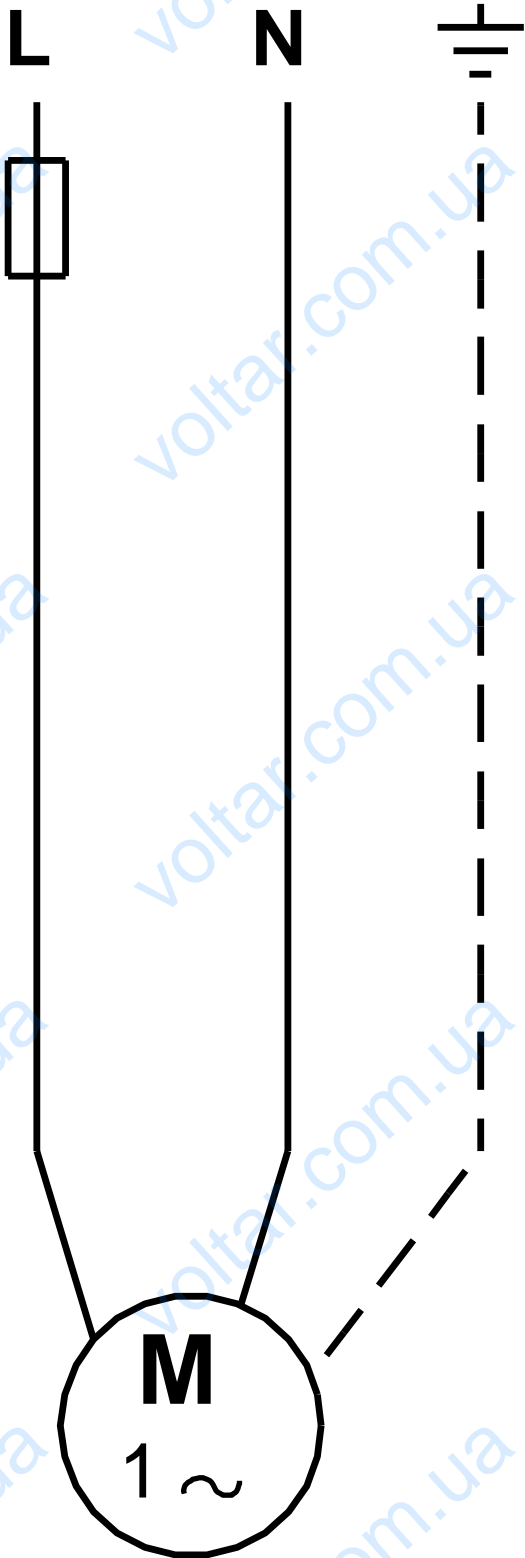

! [] .