

Side view

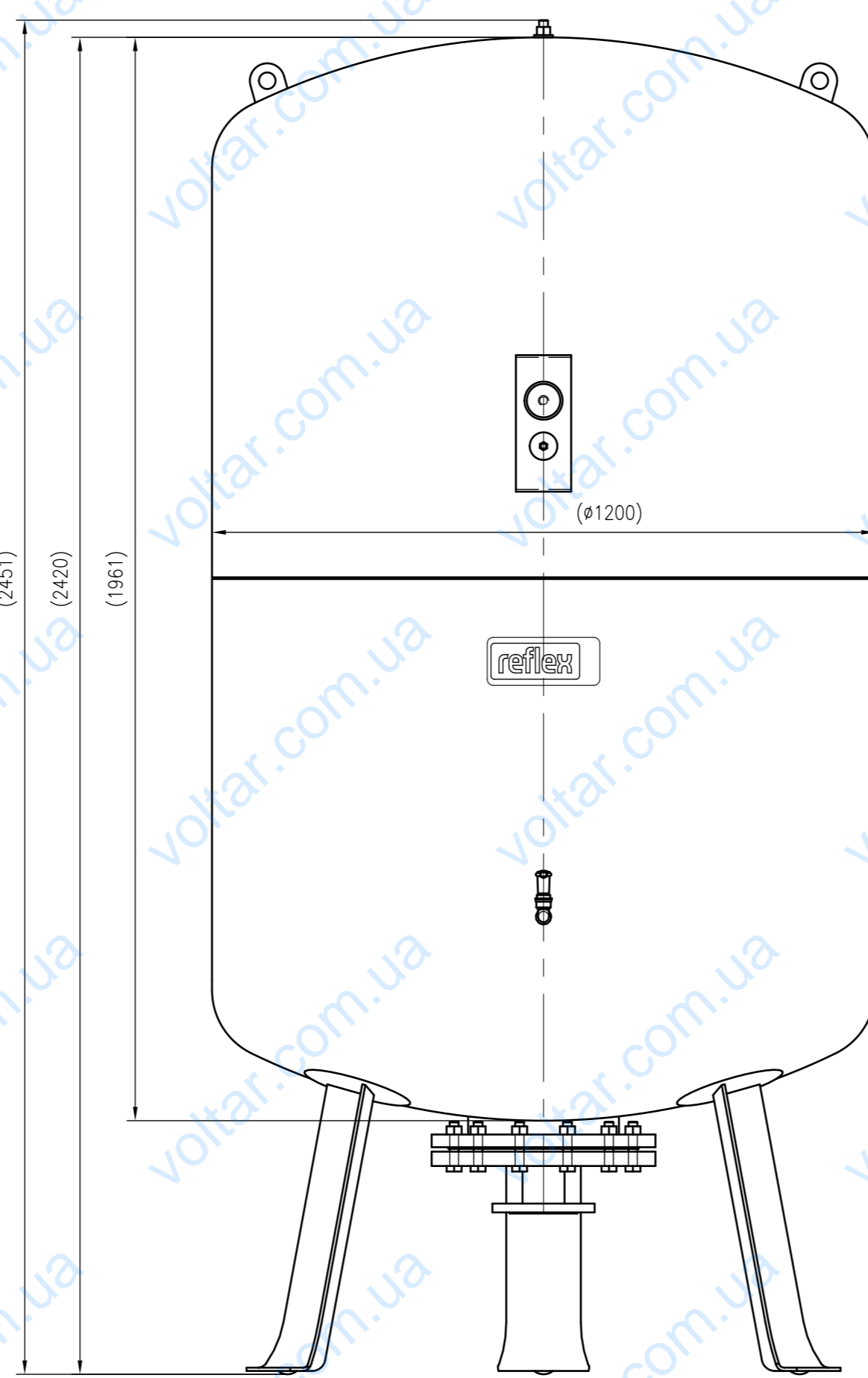

Front view

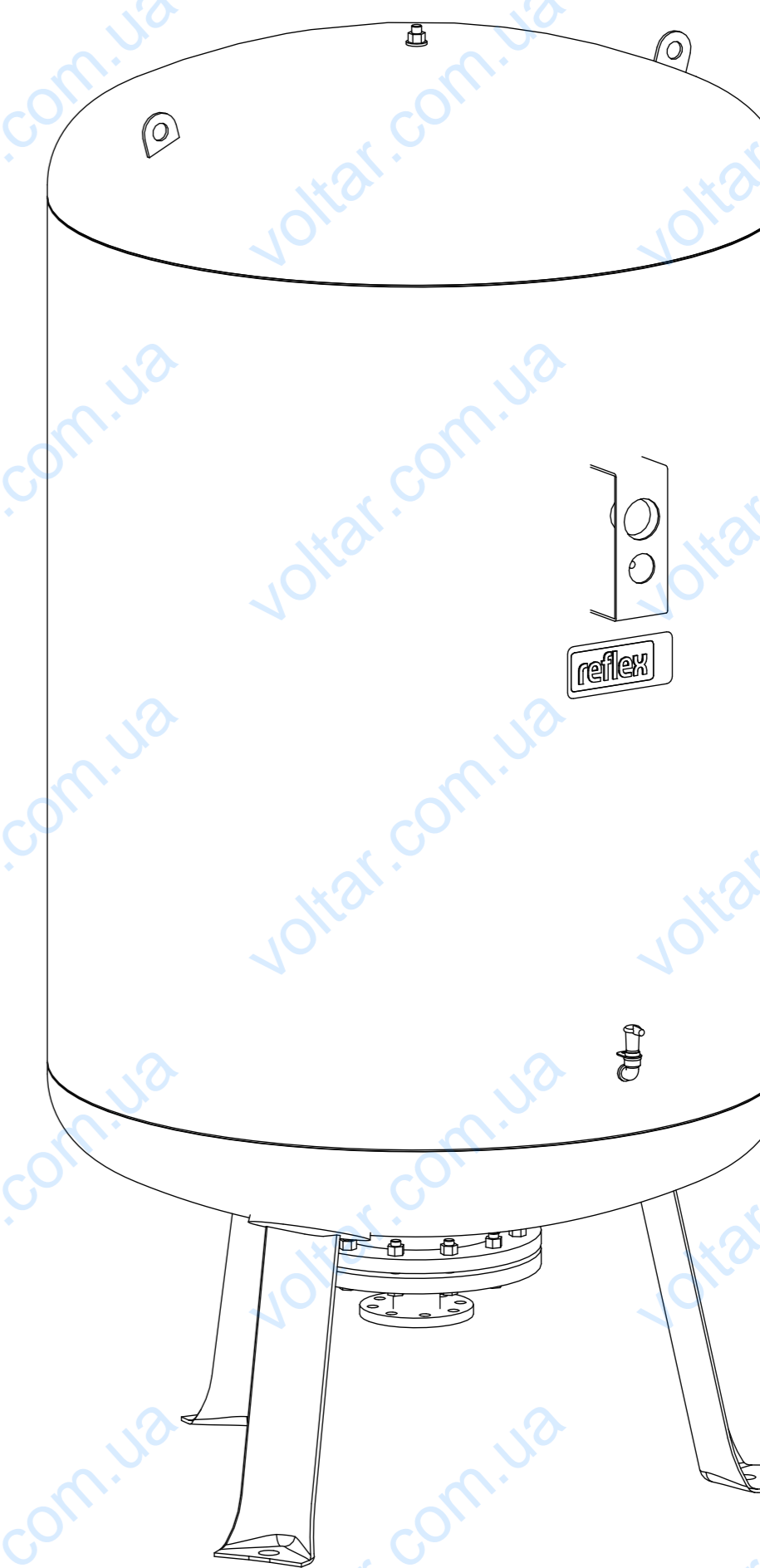

Isometric view

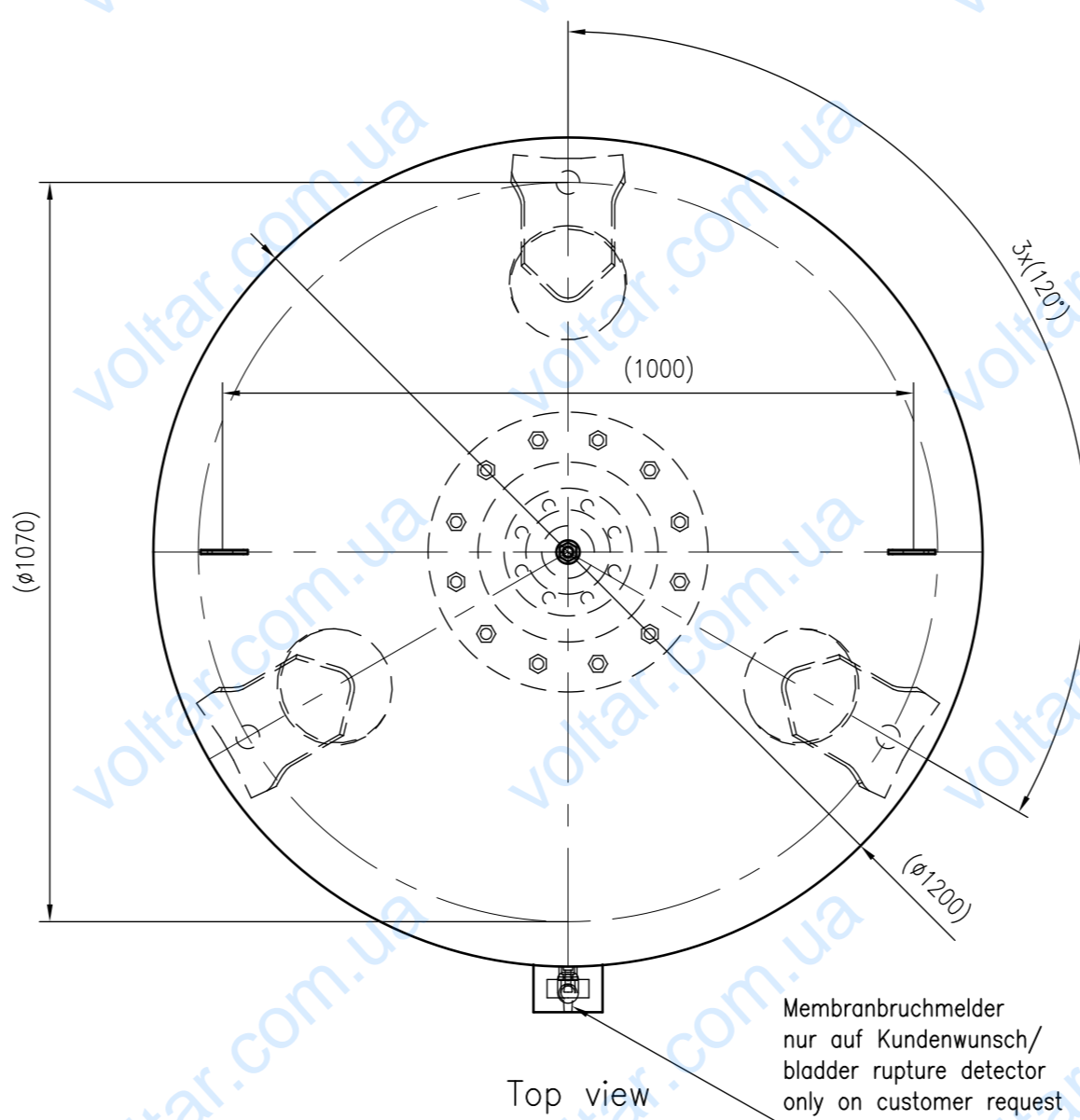

Top view



Unterliegt nicht dem Änderungsdienst/ Not subject to change management		Maßstab/ Scale: 1:10	Format/ Size: A1
Revision 18.08.2017	Refix DE 2000 10bar – 7311705		