

Side view

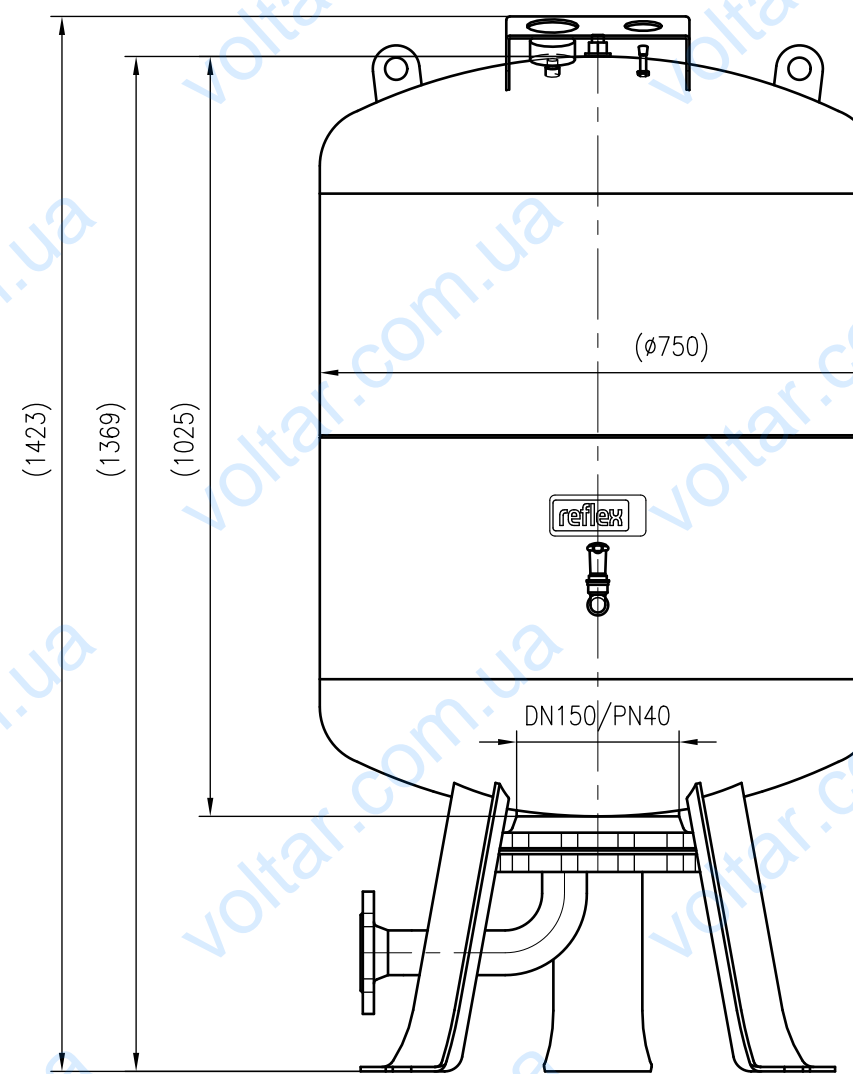

Front view

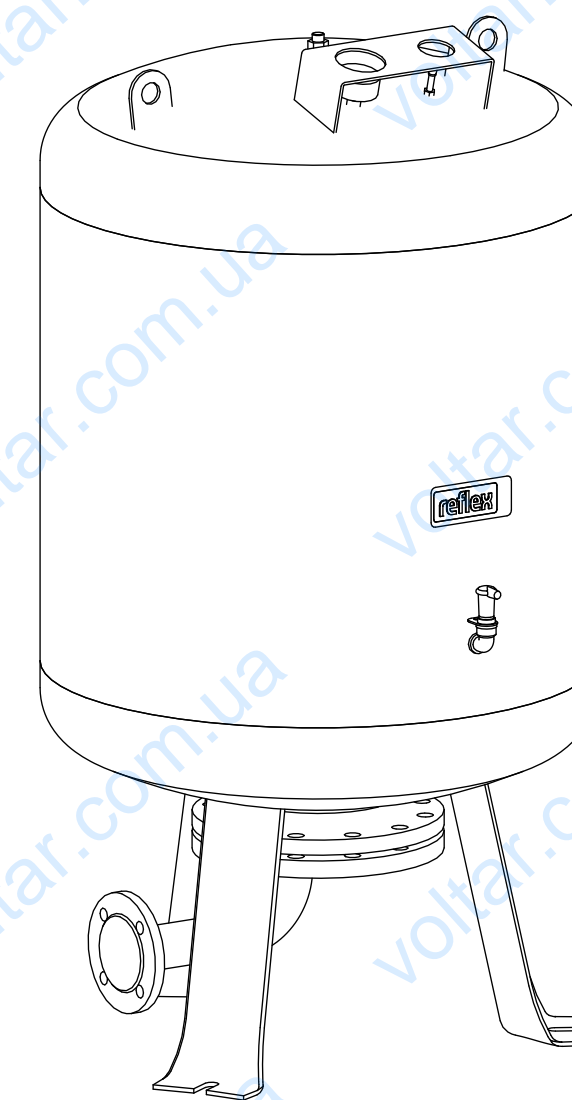

Isometric view

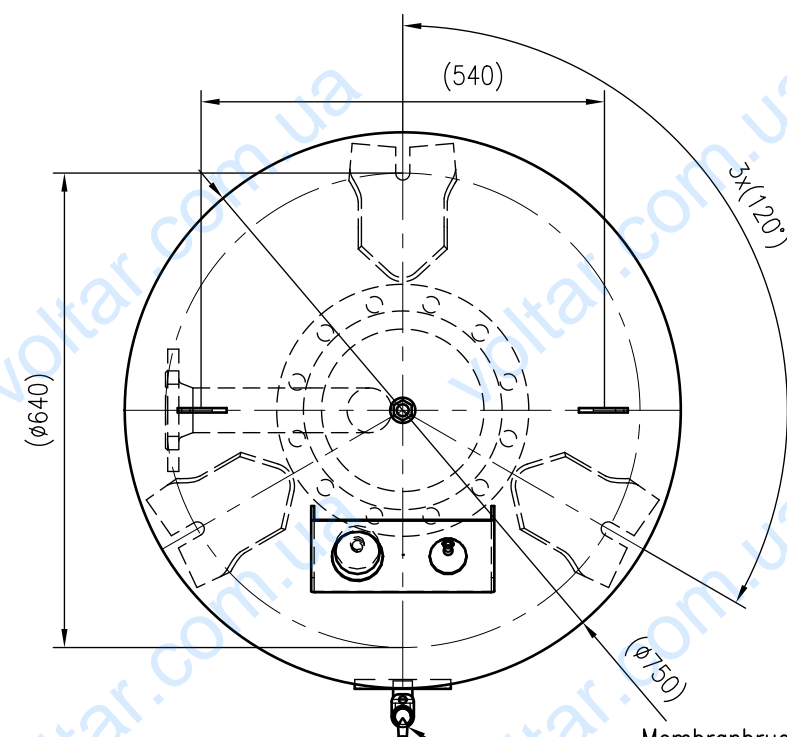

Top view

Membranbruchmelder  
nur auf Kundenwunsch/  
bladder rupture detector  
only on customer request



Unterliegt nicht dem Änderungsdienst/ Not subject to change management		Maßstab/ Scale: 1:10	Format/ Size: A2
Revision 29.04.2016	Reflex DE 400 25bar – 7313300		