

AURATON Tucana SET

Instruction manual version 20201122

The document contains information on the safety, installation, and use of the AURATON Tucana SET.

Weekly, wireless thermostat with heating device controller (set)

AURATON Tucana SET is a set of a weekly, wireless thermostat with a controller of the AURATON Fornax heating device, designed to work with a gas or electric heating device.

**ST
UV**

4 independently settable temperatures

Day, night, anti-freeze, holiday.

16 A

Work under load up to 16 A/10 A

The AURATON Fornax receiver is equipped with a relay that can operate under a load of up to 16 A/10 A. The low-spark technology of switching the mains voltage causes minimal wear of the relay contacts.



Interference-free communication between devices

The transmitter and the receiver from the Tucana R AURATON set communicate at 868 MHz. Very short, encrypted data transmission packets (approx. 0.004 sec.) ensure efficient and interference-free operation of the device.

LCD

Backlit LCD display

Due to a backlit display, we can monitor the operation of the device even in a poorly lit room (3 backlight colours to choose from).

Description of AURATON Tucana R

weekly, wireless thermostat (transmitter)

On the right side of the front part of AURATON Tucana R you will find a sliding cover. Slide it open to see the buttons. The cover can be removed for battery replacement.

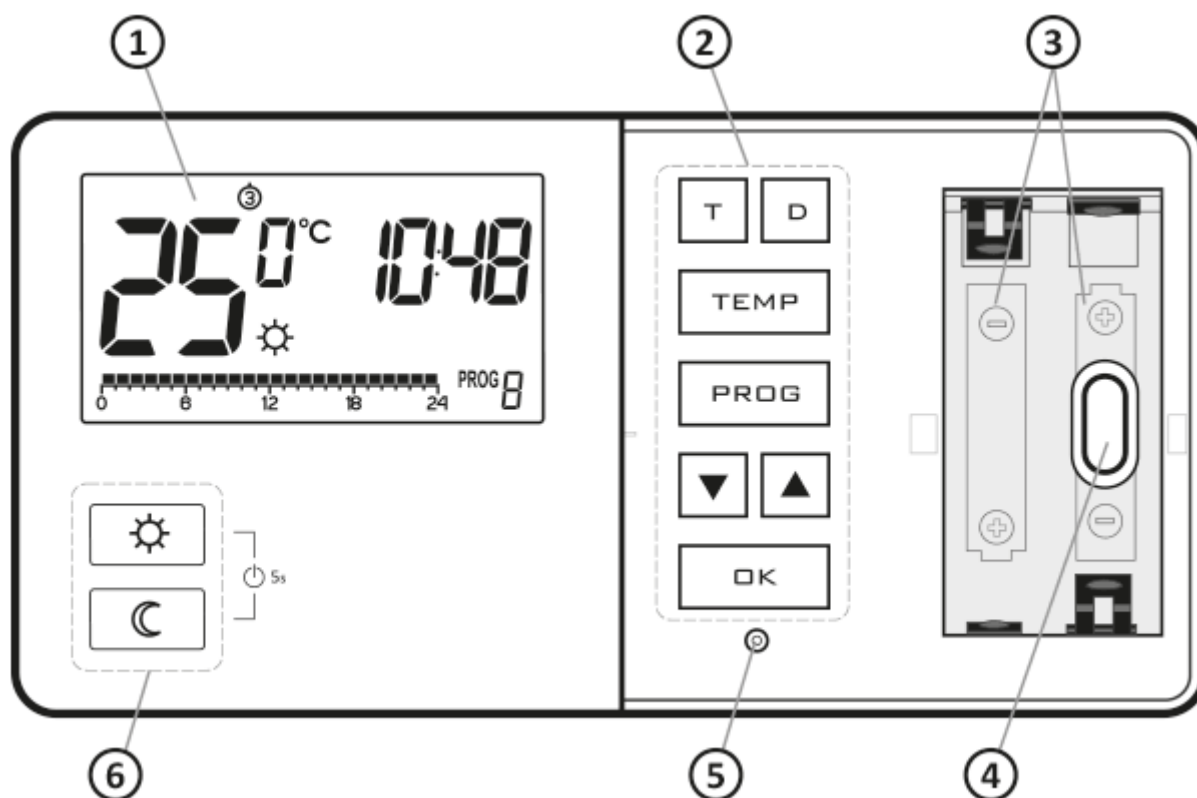

1. LCD display
2. Programming buttons
3. Place for 2 batteries (AA LR6 1.5 V)
4. Mounting hole
5. RESET button

6. Mode selection buttons:

S - day mode

T - night mode

Display

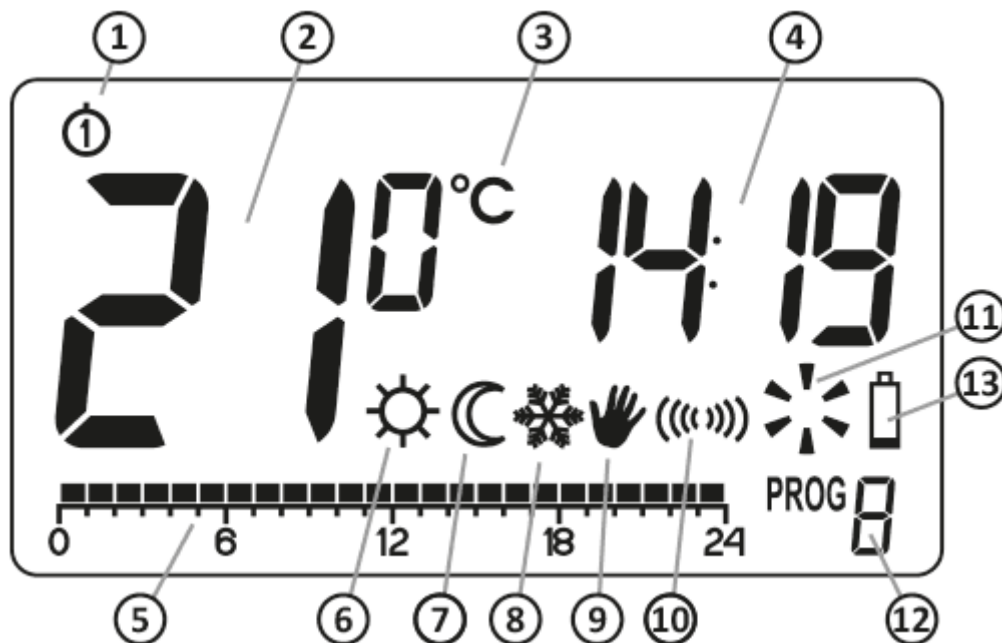

1. **Day of the week (8)** - It indicates what day of the week it is. Each day has a number assigned to it.
2. **Temperature** - In its normal operating mode, AURATON Tucana R displays the temperature in the room where it is installed.
3. **Temperature unit** - It indicates that the temperature is displayed in degrees Celsius (°C).
4. **Clock**
The time is displayed in the 24-hour system.
5. **Timeline**
Program sequence indicator. It is a line divided into 24 sections. Each section represents one hour. The line shows how the program will be executed (see chapter: 'Timeline')
6. **Day mode indicator (S)**
It indicates the operation of AURATON Tucana R in day mode. (see chapter: 'Temperature programming')

7. **Night mode indicator (T)**

It indicates the operation of AURATON Tucana R in night mode. (see chapter: 'Temperature programming')

8. **Anti-freeze mode indicator (U)**

It indicates the operation of AURATON Tucana R in anti-freeze mode (see chapter: 'Anti-freeze mode').

9. **Manual control indicator (V)**

It indicates the operation of AURATON Tucana R in manual mode (see chapters: 'Manual control' and 'Holiday mode')

10. **Broadcast symbol (=)**

It indicates communication with the AURATON Aries or AURATON Fornax receiver.

11. **AURATON Tucana R power-on symbol (Y)**

The segment showing the working status of the device. Visible when the controlled device is switched on.

12. **Program number**

It indicates the current program number (see chapters: 'Factory programs' and 'Weekly programming').

13. **Dead batteries (X)**

The indicator is visible when the minimum permissible battery voltage level is exceeded. The batteries need to be replaced as soon as possible.

IMPORTANT:

In order to maintain any programmed parameters, the battery replacement operation should not exceed 30 seconds.

Choosing the right location for AURATON Tucana R

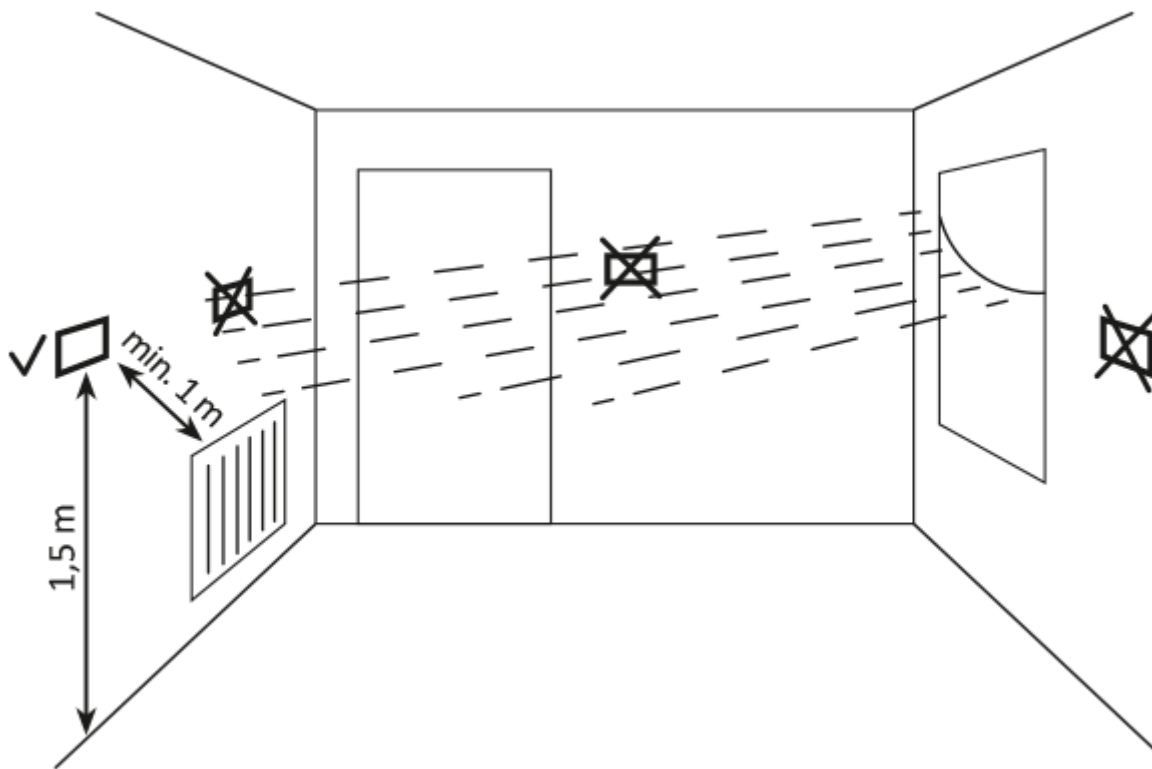

The correct operation of AURATON Tucana R is largely influenced by its location. Using the device in a place with no air circulation or a place with direct sunlight may result in incorrect temperature control. AURATON Tucana R should be installed on the internal wall of a building (a partition wall), in an environment with free air circulation. You should avoid proximity to heat-emitting devices (TV, heaters, refrigerators) or locations exposed to direct sunlight. The vicinity of doors and exposing AURATON Tucana R to possible vibrations may also cause problems with proper operation of the device.

Battery replacement



If the low battery symbol (**X**) appears on the display, it means that the battery level has fallen to the minimum allowable level. Replace the batteries as soon as possible.

IMPORTANT:

In order to maintain any programmed parameters, the battery replacement operation should not exceed 30 seconds.

IMPORTANT:

We recommend using alkaline batteries to power AURATON thermostats. Do not use “rechargeable batteries” because their rated voltage is too low.

Mounting AURATON Tucana R - weekly, wireless thermostat

To mount AURATON Tucana R to the wall:

1. Drill two holes 6 mm in diameter in the wall (mark the hole spacing using the template attached to the manual).
2. Insert the wall plugs (included).
3. Tighten the left screw with a 3 mm clearance.
4. Place AURATON Tucana R through the screw head and slide to the right (note the keyhole-like opening on the rear cover of AURATON Tucana R).

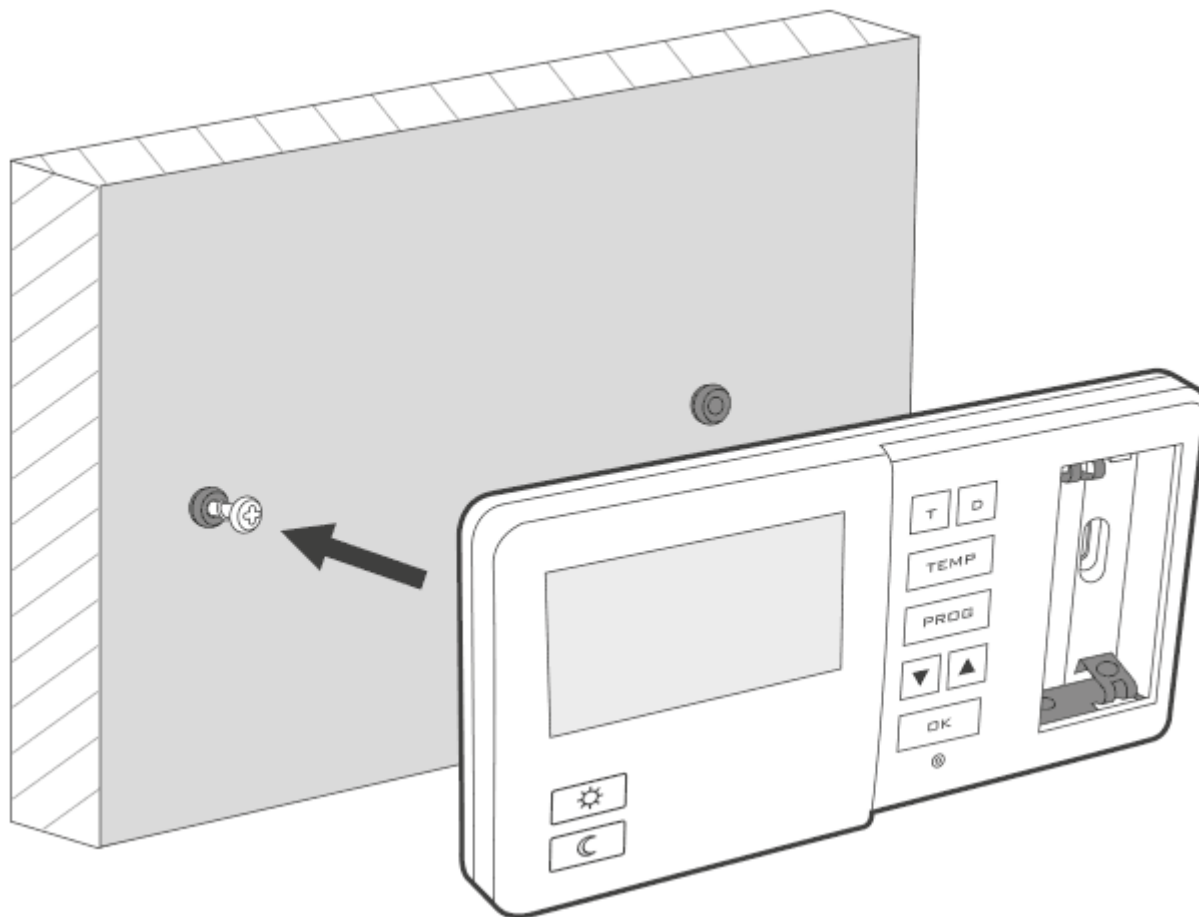

5. Tighten up the right screw so that it holds AURATON Tucana R mounted securely.

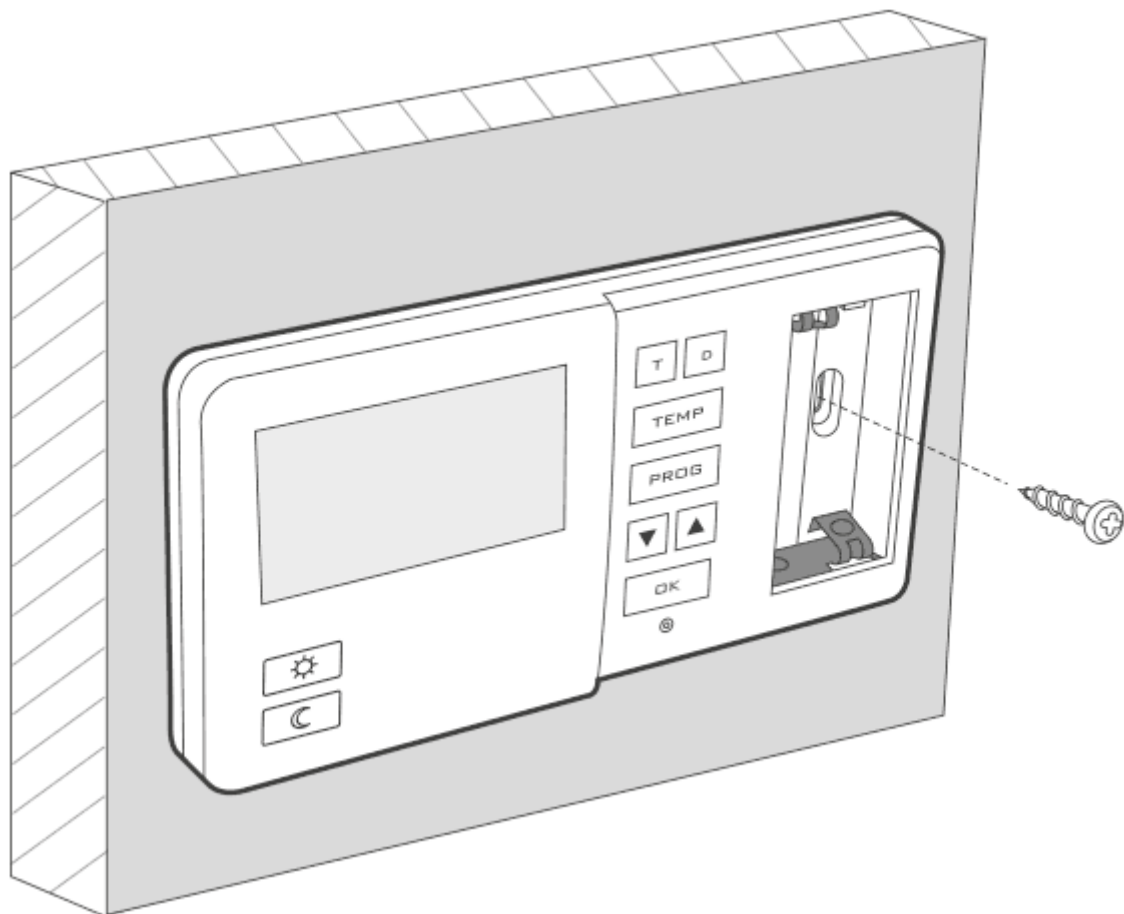

NOTE:

In the case of a wooden wall, there is no need to use wall plugs. It is enough to drill holes with a diameter of 2.7 mm (instead of 6 mm) and screw the screws directly into the wood.

Turning AURATON Tucana R on for the first time

After inserting the batteries correctly into the battery compartment, the LCD screen will display all the segments for a second (display test) and then the software version number.

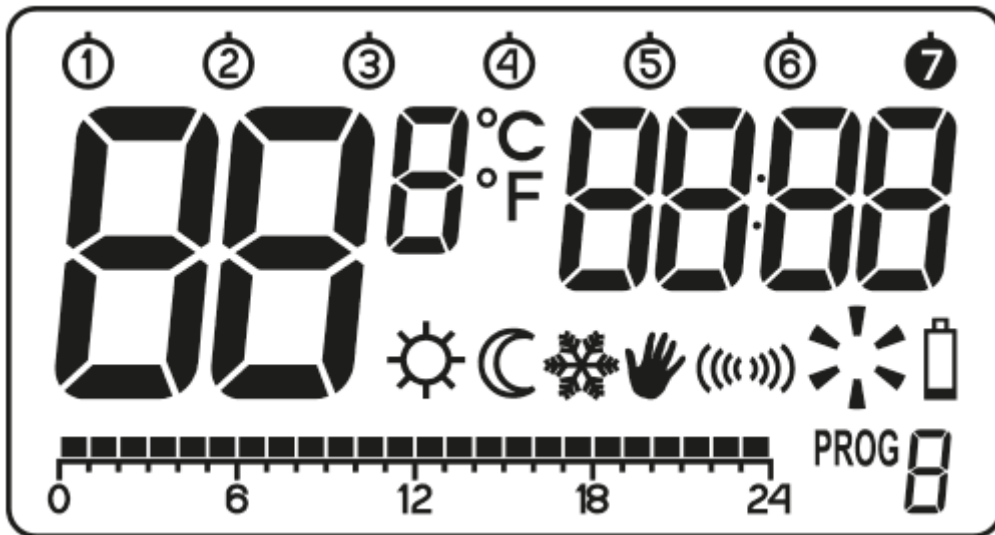

After a while, AURATON Tucana R will automatically go to the hour setting. An item flashing on the screen indicates that it is currently in editing mode. Use the **bc** buttons to set the desired hour and confirm the setting with the **i** button.

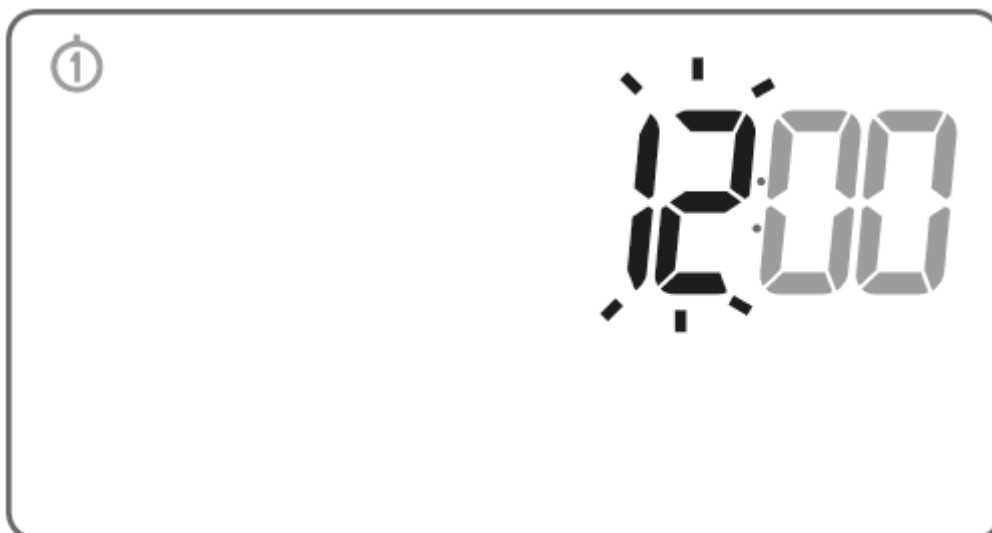

Tucana AURATON will go to the minute setting. Use the **bc** buttons again to set the desired minute value and confirm the setting by pressing the **i** button.



A flashing day of the week symbol appears in the upper left corner. Use the **bc** buttons to set the desired day and confirm the selection with the **i** button. Tucana AURATON will enter its normal operating mode.



NOTE:

If no button is pressed for 60 seconds during the initial hour setting, AURATON Tucana R will automatically enter its normal operating mode.

NOTE:

If no button is pressed for 10 seconds during the programming of any other functions, it is equivalent to using the **i** button.

Setting the clock

To set the clock:

1. Press the **k**. button. The hour segment will start flashing on the display.
2. Use the **bc** buttons to set the correct hour.

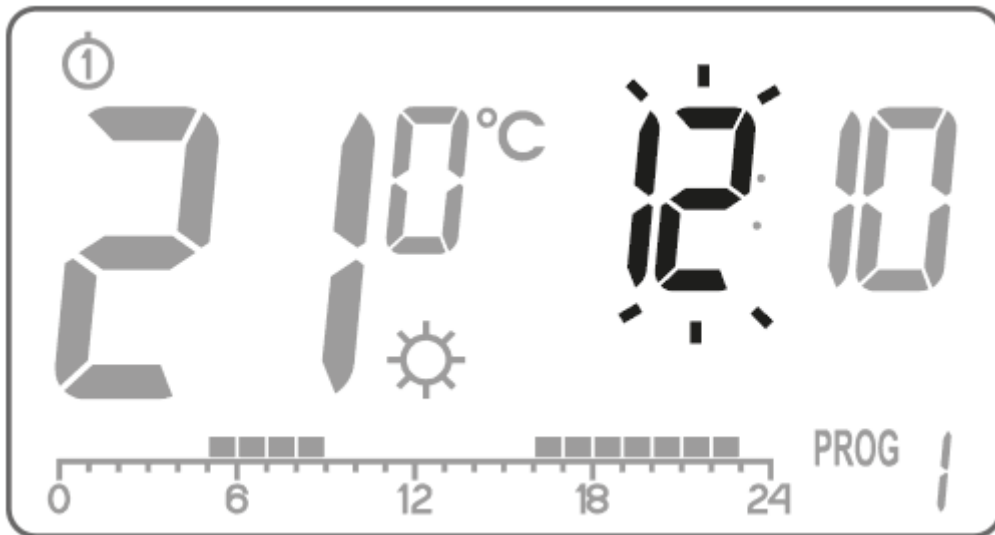

3. Then press the **k** button again. The minute segment starts flashing.
4. Use the **bc** buttons to set the desired minute value.
5. Confirm the above settings with the **i** button.

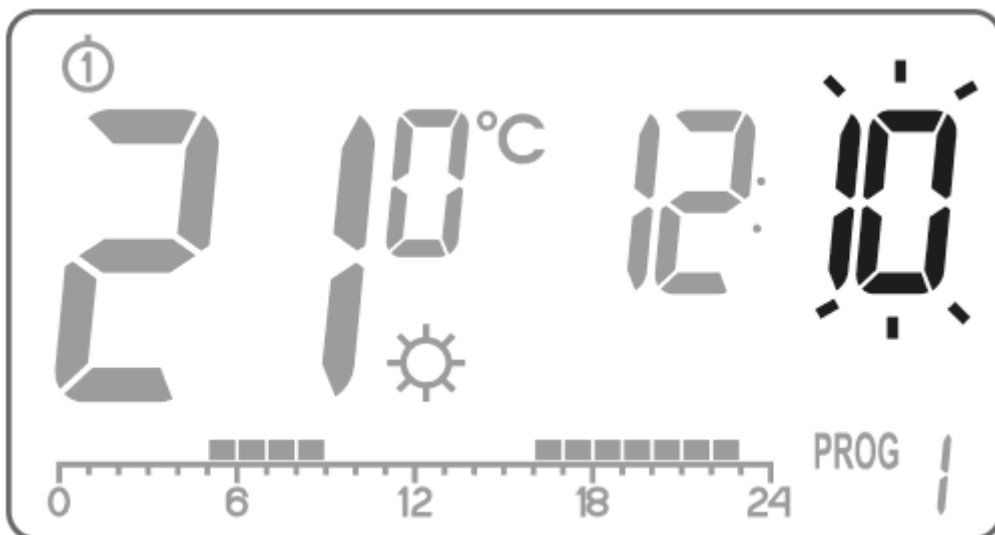

Selecting the day of the week

8

To set the day of the week:

1. Press the **I** button. One of the digits symbolising the relevant day of the week will start flashing on the display.
2. Use the **bc** buttons to select the correct day of the week.
3. Confirm the above settings with the **i** button.

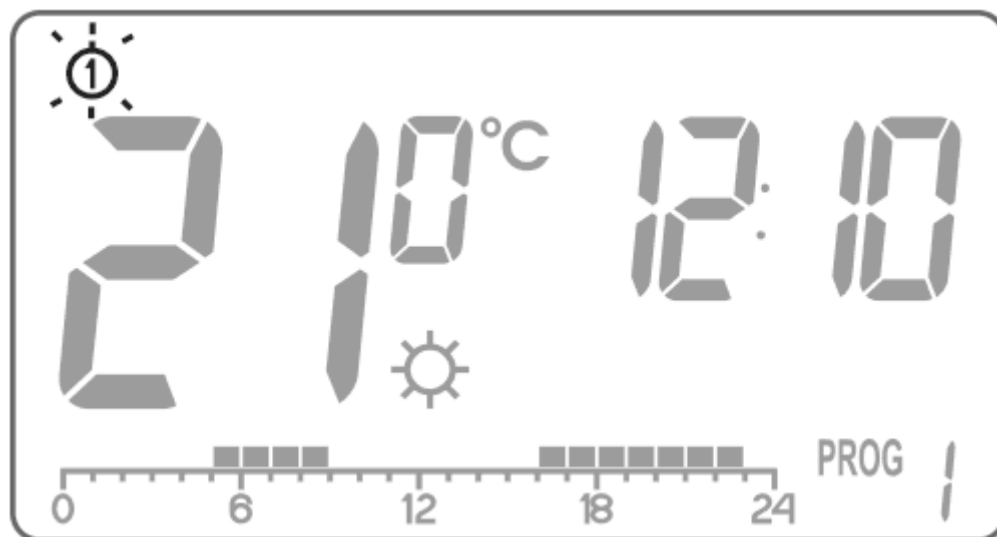

LO HI temperature

If the ambient temperature is below **5 °C**, the display will show '**LO**'.

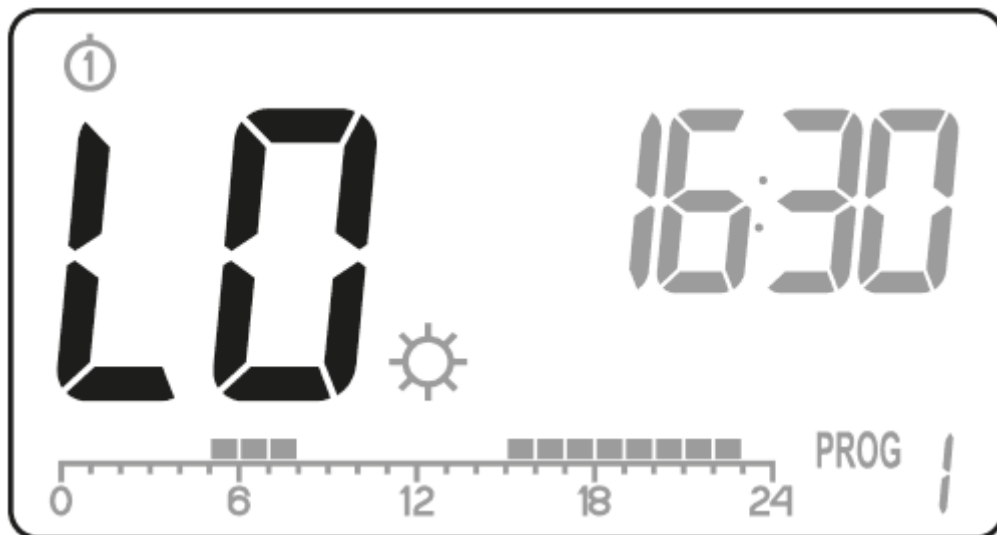

If the ambient temperature is above **35 °C**, the display will show '**HI**'.

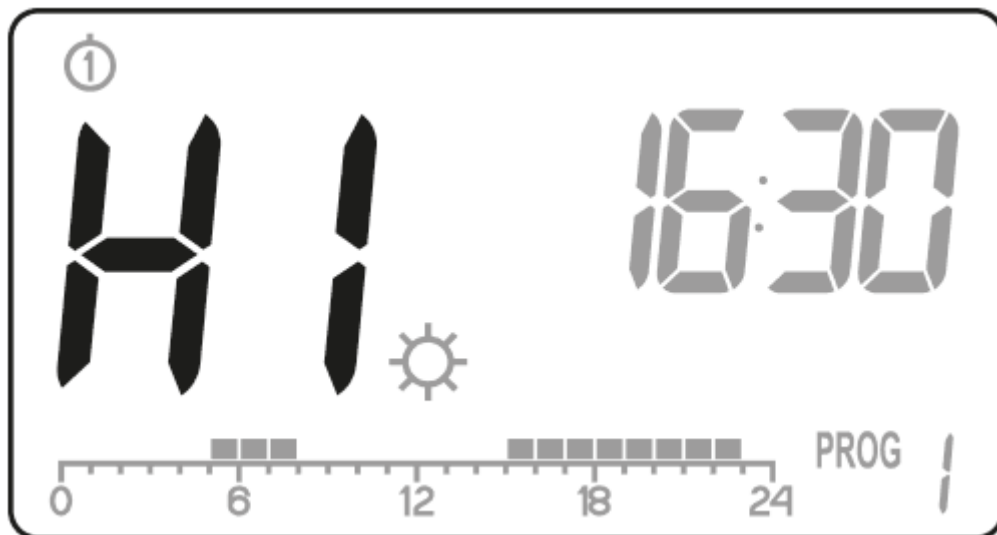

Default program settings

- **Monday - Friday:**

the heating device achieves the day temperature (**S**) between **05:00 and 8:00** and between **15:00 and 23:00**

- **Saturday - Sunday:**

the heating device achieves the day temperature (**S**) between **06:00 and 23:00**

- **default temperature settings:**

S day temperature - 21,0 °C

T night temperature - 19,0 °C

U anti-freeze temperature - 7,0 °C

Programming the day, night and anti-freeze temperatures

AURATON Tucana R allows you to program 3 types of temperature:

- Day temperature (**S**) - from 5 to 30 °C
- Night temperature (**T**) - from 5 to 30 °C
- Anti-freeze temperature (**U**) - from 4 to 10 °C

To set one of the above temperatures:

1. Press the **?** button.

The display will show the currently set temperature with the following symbol:

S - day temperature,

T - night temperature,

U - anti-freeze temperature.



3. Use the **bc** buttons to set the desired temperature.
4. By pressing the **?** button again, toggle between the subsequent types of temperatures to be set (**S, T, U**).
5. After setting all the 3 temperatures, confirm the settings with the **i** button.

IMPORTANT:

The night temperature setting can be equal to or lower than the day temperature. It is impossible for the night temperature to be higher than the day temperature.

Introduction to programming

Timeline

The timeline on the LCD display is divided into 24 sections. Each of them symbolizes 1 hour of the day. Black rectangles above the timeline mean that the day temperature has been programmed for specific hours, and that there is no night temperature.

Example:

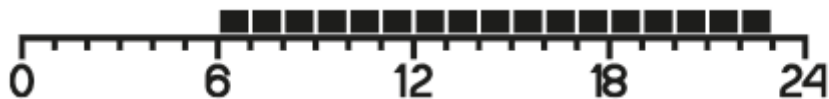

The figure above shows that from 6.00 A.M. to 11.00 P.M. Auraton Tucana R will control the heating device in such a way that the room temperature will be day temperature (S). AURATON Tucana R will switch to night temperature (T) from 11.00 P.M. to 6.00 A.M.

Factory programs

In order for AURATON Tucana R to know when to turn on the day and night temperatures, you should be set to an appropriate program for each day of the week. For this purpose, you can use one of the three factory programs (from 0 to 2):

Program no. 0 - anti-freezing U

Unmodifiable factory program. Designed for all-day anti-freezing temperature setting.

Program no. 1 - weekly

Unmodifiable factory program. Sets day temperature from 5:00 to 8:00 A.M. and from 3:00 to 11:00 P.M.

Program no. 2 - weekend

Unmodifiable factory program. Sets day temperature from 6:00 A.M. to 11:00 P.M.

Programs no. 3, 4, ..., 9 - user-defined programs

Programs from 3 to 9 are user-defined programs. They can be freely modified and adapted to specific requirements.

Programming

Weekly programming

In order to program the AURATON Tucana R, it is necessary to decide on which day of the week and during what period of time the day temperature should be maintained. During the remaining time, the night temperature will be maintained.

An exemplary mode of operation of the AURATON Tucana R from Monday until Sunday. Besides the defined periods of time, the AURATON Tucana R maintains the lower night temperature.

Day of week	Day temperature	
Monday	5:00 - 8:00; 15:00 - 23:00	<input type="checkbox"/>
Tuesday	5:00 - 8:00; 15:00 - 23:00	<input type="checkbox"/>
Wednesday	5:00 - 8:00; 15:00 - 23:00	<input type="checkbox"/>
Thursday	5:00 - 8:00; 15:00 - 23:00	<input type="checkbox"/>
Friday	5:00 - 8:00; 15:00 - 23:00	<input type="checkbox"/>
Saturday	8:00 - 23:00	<input type="checkbox"/>
Sunday	8:00 - 23:00	<input type="checkbox"/>

Selecting a program

In order to select a program:

Press the **h** button. The program description field starts flashing.

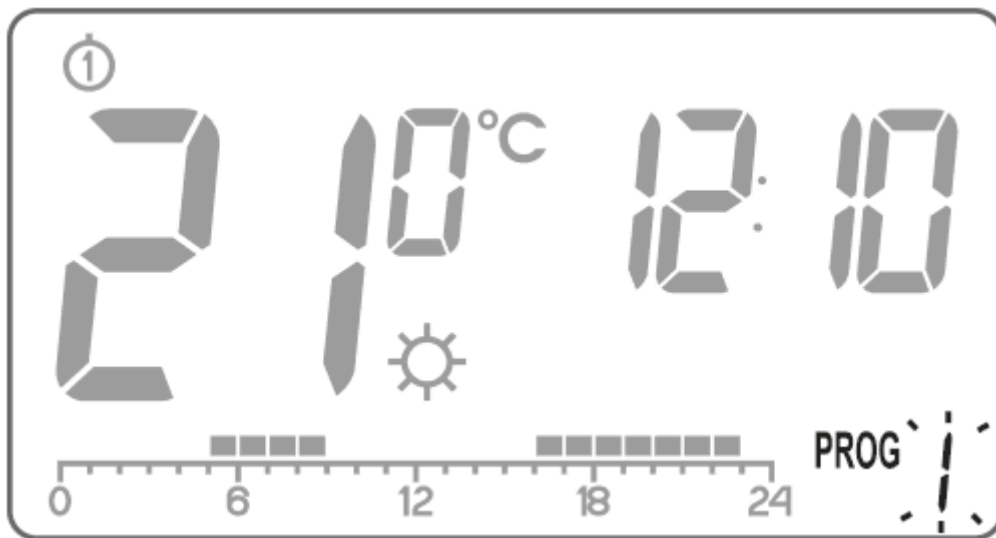

Press the **l** button. Using the **bc** buttons or the **l** button set the day of the week when the program should be executed.

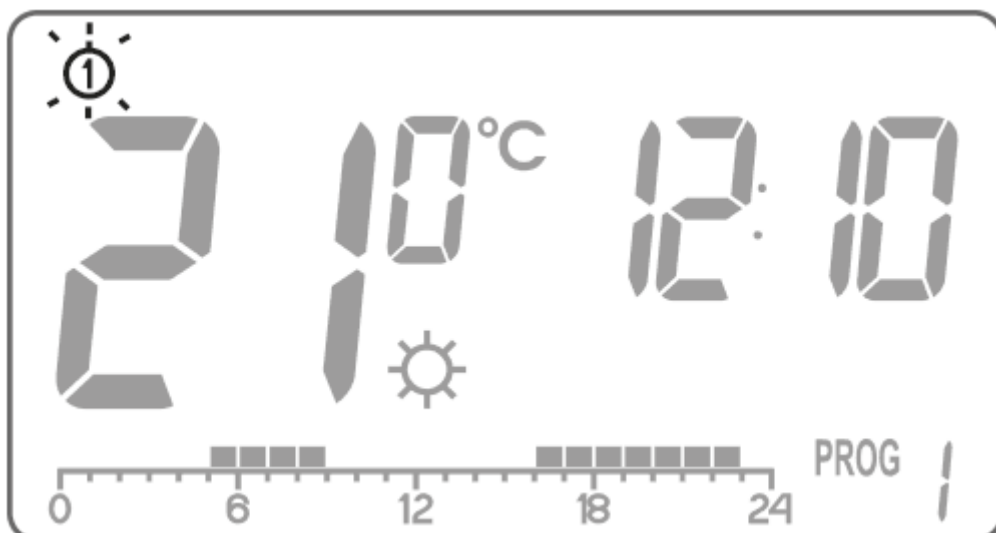

Pressing the **h** button several times, select the desired program number. Programs no. **0-2** are factory-defined and programs no. **3-9** can be modified.

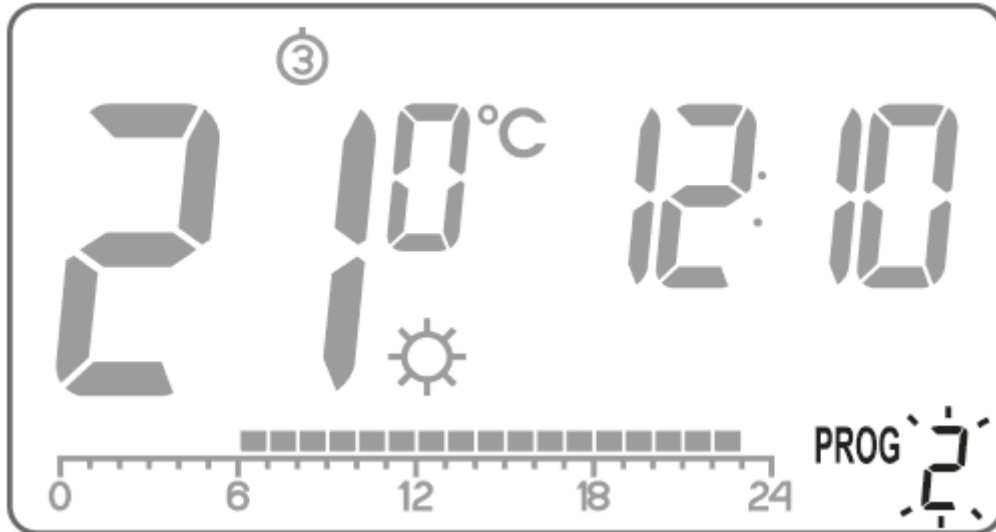

4. Confirm the setting with the **i** button.
5. Return to step 1 and repeat the above procedure for the next day of the week. Programming can end when each day of week is assigned an appropriate program.

Modifying user programs

In order to modify a program:

Press the **h** button. The program description field starts flashing.

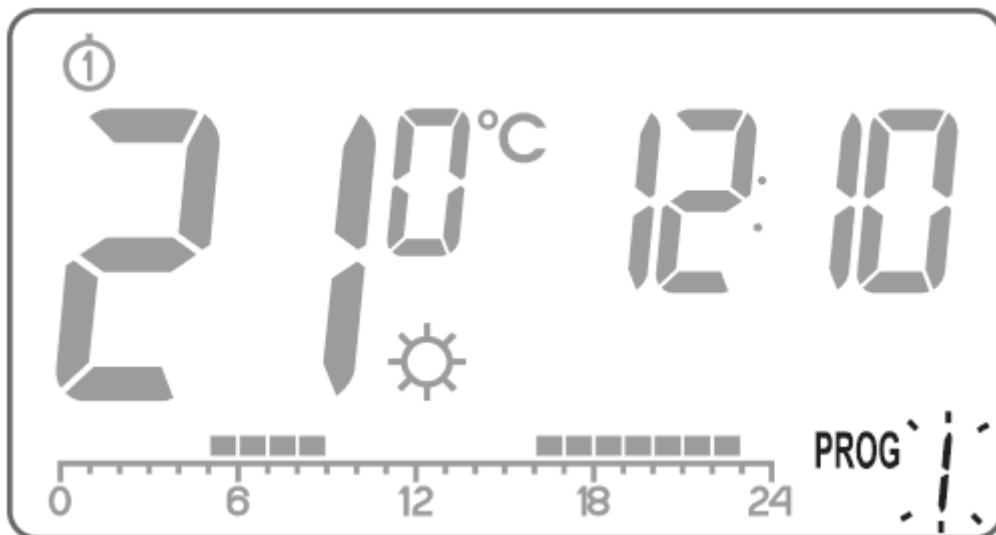

Press the **I** button. Using the **bc** buttons or the **I** button, set the day of the week when the program should be executed.

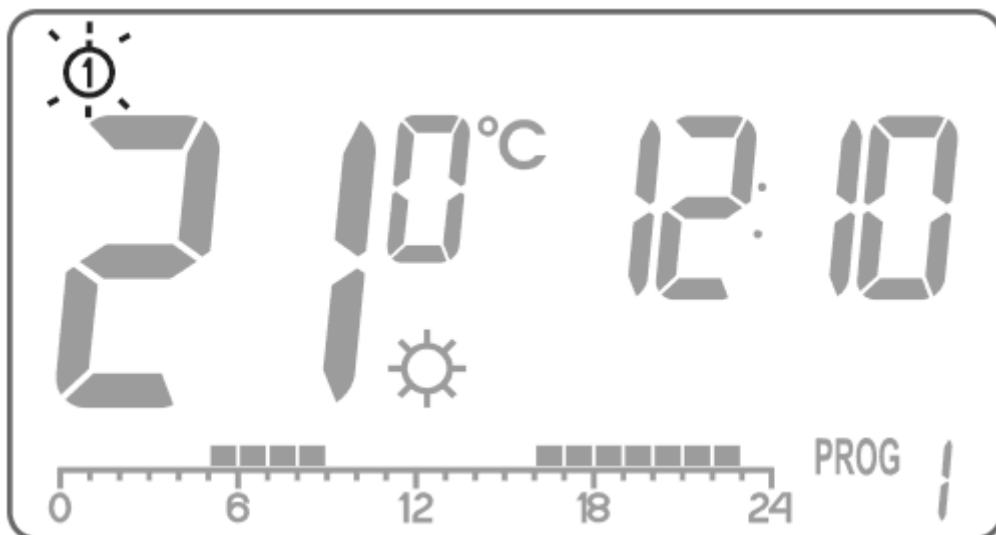

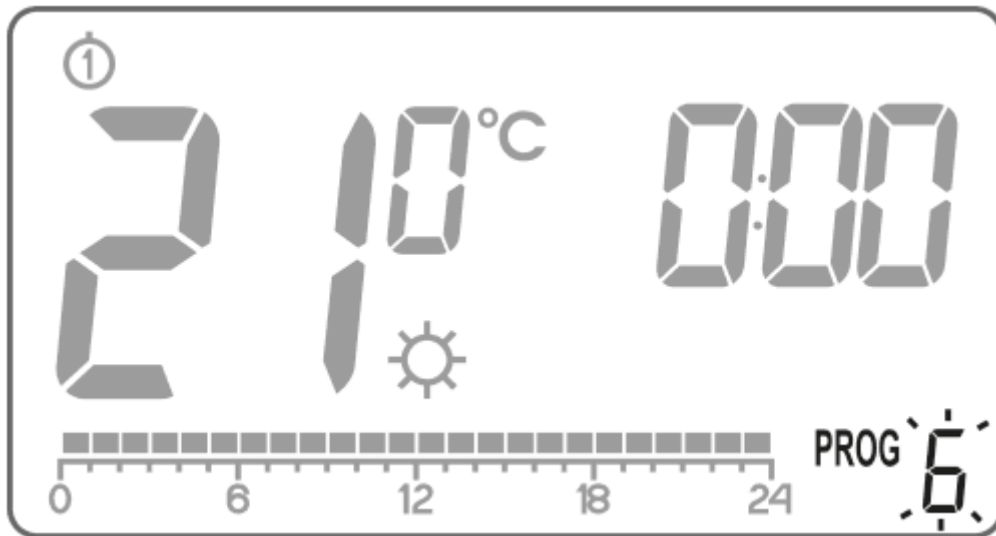

Press the **h** button several times and select program number 3 to 9 (user modifiable).

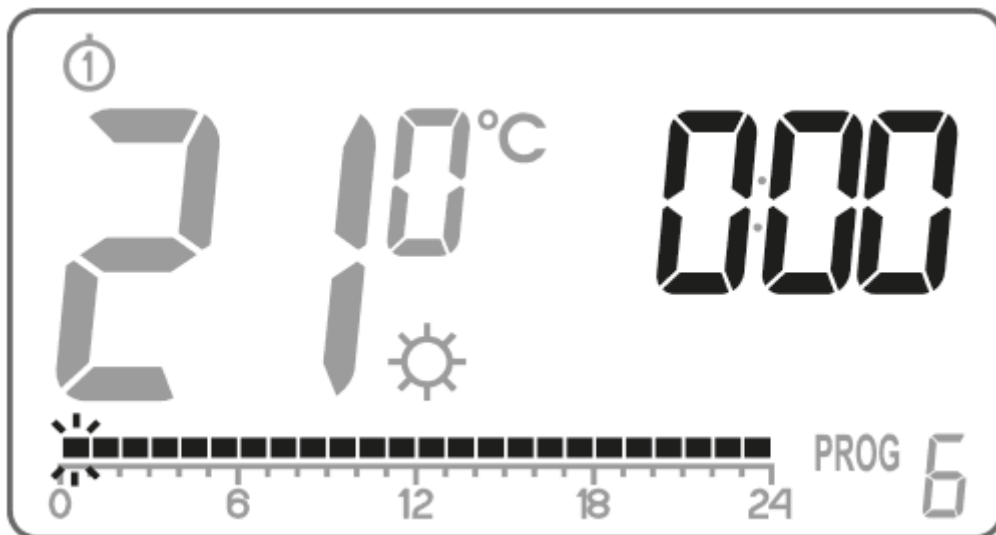

All (24) black rectangles will be lit on the timeline, each symbolising 1 hour. A visible rectangle means that the day temperature is to be achieved during a given hour. No rectangle above the timeline is tantamount to planning the night temperature.

A flashing rectangle indicates the place where changes are being made on the timeline.



Press the  or  button to select the day temperature (a lit rectangle) or the night temperature (no rectangle) on the timeline.

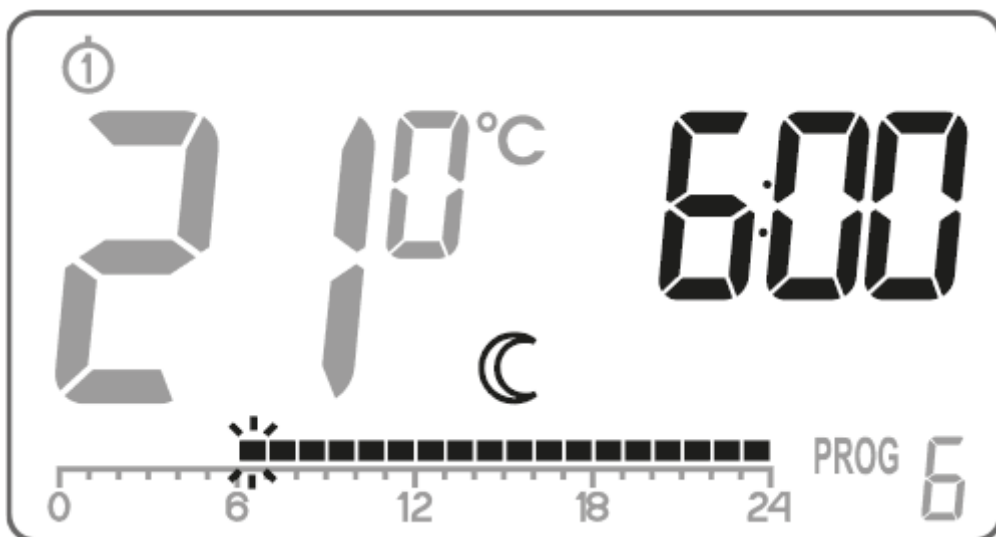

Use the **bc** buttons to highlight subsequent hours on the timeline and select the day or night temperature for each hour (we toggle between a lit rectangle and no rectangle with the **; :** buttons).

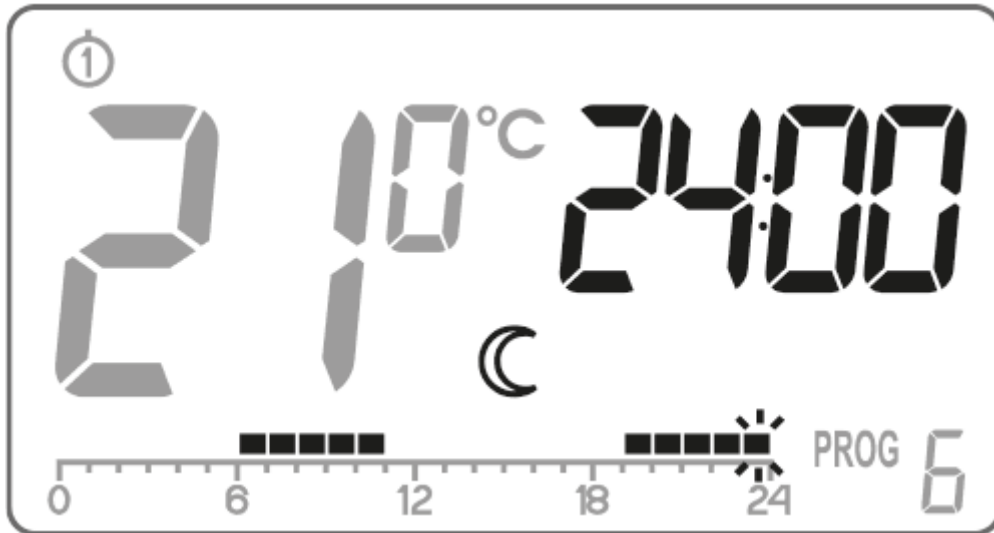

7. After modifying the whole timeline, save the program with the **i** button.

NOTE:

A program once modified can be assigned to different days of the week by selecting it on the desired day of the week.

Manual control

V

If you want to discontinue the current program operation and extend maintaining the day temperature for any reason, you can do it manually. To do this, you should:

1. Press the **;** button. The **V** symbol appears on the display. The comfort temperature will then be maintained until the next change of temperature to be achieved by the program.
2. To deactivate the above-mentioned function, press the **I** button located under the battery cover - the **V** symbol will then disappear from the display.

Similarly, if you want to discontinue the current program operation and extend maintaining the night temperature for any reason, you should:

1. Press the **;** button. The **V** symbol appears on the display. The comfort temperature will then be maintained until the next change of temperature to be achieved by the program.
2. Press the **I** button to deactivate the above-mentioned function.

Holiday mode

We sometimes leave our homes for longer periods. To avoid reprogramming the whole AURATON Tucana R device, we can use the holiday mode, which makes AURATON Tucana R achieve only one temperature during our absence. The holiday mode can last from a minimum of 1 hour and to a maximum of 99 days.

To activate the holiday mode:

1. Press and hold the **⏏** or **;** button for 3 seconds. The display will show the temperature and a flashing time field for setting the holiday mode duration.
2. Use the **bc** buttons to set the duration at 1 to 23 hours and then 1 to 99 days. Confirm the setting with the **⏏** button.



3. The temperature field starts flashing. It can be set with the **bc** buttons. Confirm the selection with the **⏏** button.



If the selection is not confirmed, AURATON Tucana R will automatically switch to the holiday mode set after 10 seconds. Press the **I** button to exit the holiday mode.

NOTE:

The holiday temperature is independent of the day, night or anti-freeze temperatures.

Setting the anti-freeze temperature program

U

In AURATON Tucana R, you can set the anti-freeze temperature in the range of 0 °C to 10 °C but it cannot be deactivated (the factory setting of the anti-freeze temperature is 7 °C).

In the case of a prolonged period of absence, it is possible to activate the anti-freeze temperature mode. It allows to avoid unpleasant consequences of the freezing of water in the heating system by automatically setting the temperature in the range of 0 °C to 10 °C. To set up the anti-freeze program, simply select **program 0** on the desired day of the week.

Heating device operating time meter

AURATON Tucana R has a function of measuring the operating time of the heating device. It is activated by pressing and holding the **I** button for 5 seconds. For 10 seconds, the thermostat display will show the operating time of the heating device since the last reset of the device.

NOTE:

The time may be different from the actual operating time of the heating device, e.g. due to the existence of internal thermostats installed in heating devices.

Turning off the relay temporarily

After the heating season, to avoid accidental switching on of the heating device, you can turn off the relay in AURATON Fornax.

Pressing and holding the **⏏** and **⏏** buttons simultaneously for 5 seconds will turn off the relay (a minimum temperature of 4 °C will be maintained) and all display elements except the current temperature, time and day of the week will fade out.

To restore all the Tucana AURATON functions, press and hold the **⏏** and **⏏** buttons again for 5 seconds.

Description of the AURATON Fornax

weekly, wired thermostat (transmitter)

AURATON Fornax (receiver) cooperates with the wireless AURATON Pavo R regulator (transmitter). The receiver is mounted next to the heating device and can work under a load up to **16 A/10 A** .

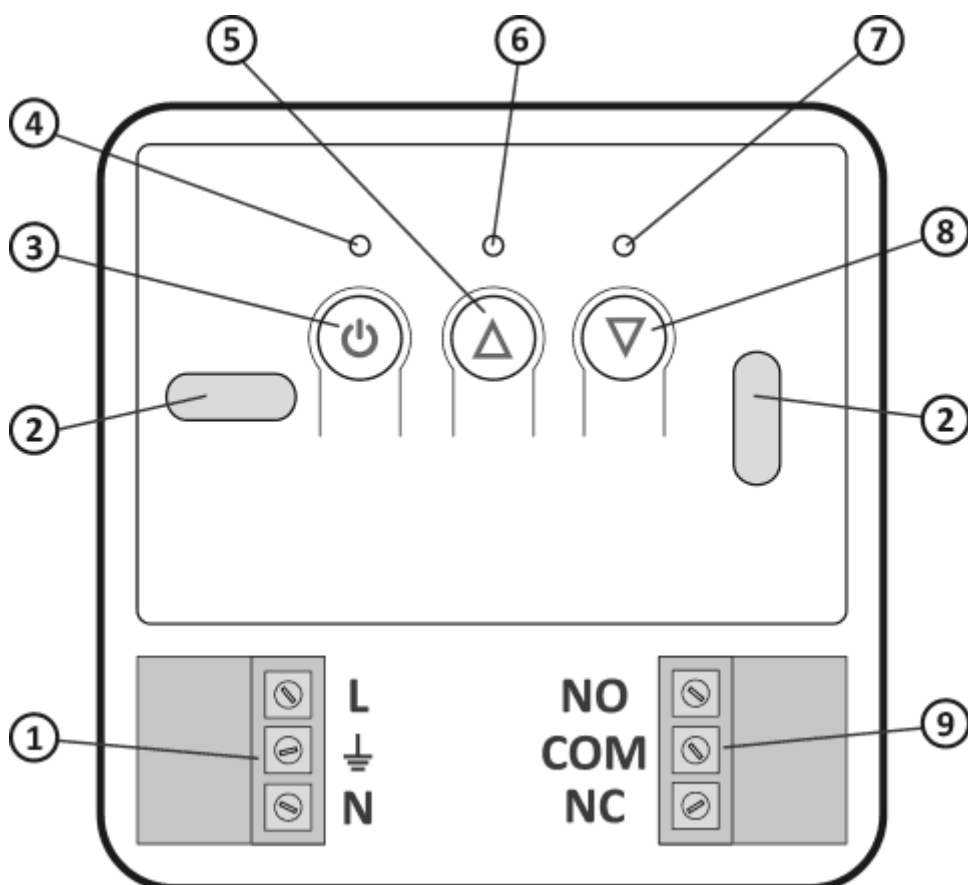

1. Detachable power connector terminals 230 V AC
2. Mounting hole
3. Power button
4. Power supply diode
5. Button to unpair devices
6. Diode indicating that the actuator device is switched on
7. Diode indicating that the actuator device has been switched off

8. Button to pair devices with the receiver
9. Control connectors

Legend - description of diode signalling

DG	The diode is green - the actuator device is switched off (the COM and NC contacts are closed).
EI	The diode is red - the actuator device is switched on (the COM and NO contacts are closed).
DH	The diode is blinking green - the AURATON Fornax receiver is waiting for device pairing - <i>chapter: "Pairing the AURATON wireless thermostat (transmitter) with AURATON Fornax - heating device controller (receiver)"</i> .
EJ	The diode is blinking red - the AURATON Fornax receiver is waiting for the previously paired device to be unpaired - <i>chapter: "Unpairing a thermostat paired with AURATON Fornax - heating device controller (receiver)"</i> .
K	The LED alternates blinking red and green: ALARM - the AURATON Fornax receiver has lost connection with the paired device - <i>chapter: "Special cases"</i> RESET - the AURATON Fornax receiver. Removal of all devices paired with the AURATON Fornax receiver - heating device controller.
F	Green power diode - the AURATON Fornax receiver is on.

Mounting AURATON Fornax - heating device controller (receiver)

P **WARNING!**

Q **The cables supplied with the thermostat are designed to transfer a load of max. value of 2.5 A.**

In the case of connecting devices with higher power, they should be replaced with wires of appropriate cross-section.

NOTE:

while installing the AURATON Fornax receiver, the power supply should be turned off. It is recommended to entrust the installation of the receiver to a specialist.

NOTE:

There must be a switch and overcurrent protection in the fixed building installation.

NOTE:

For easier installation, the connections are equipped with pull-out clips. Before connecting wires, you can disconnect them from AURATON Fornax. Wires can be routed from the bottom of AURATON Fornax after holes are punched in the mounting plug or from the back of AURATON Fornax if the wires are pulled out of the wall. To connect from the back, break the plug.

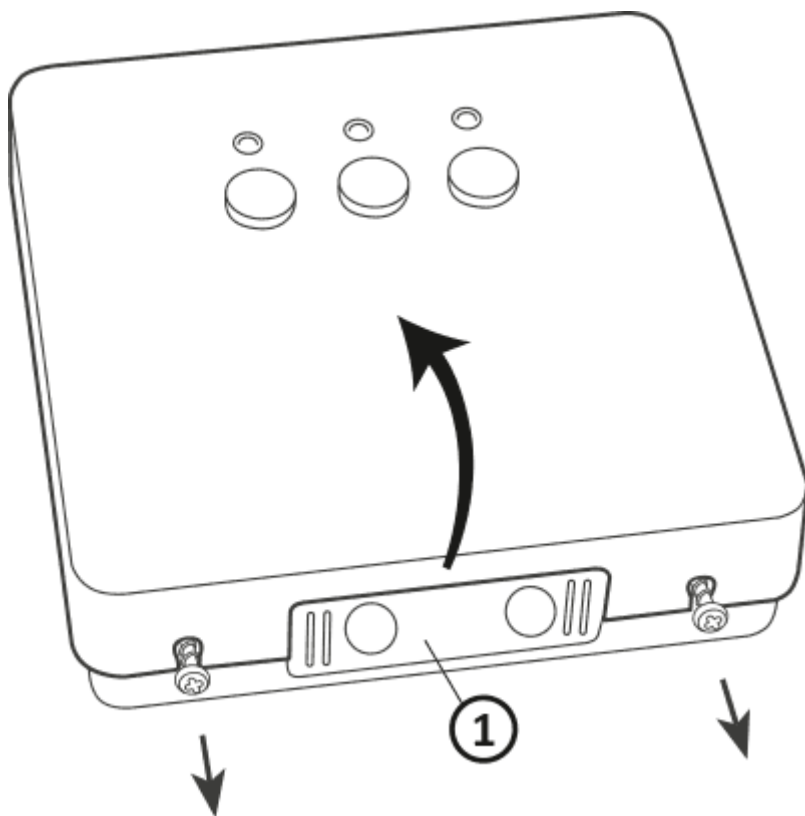

1. mounting plug

Remove the cover of the front part of Auraton Fornax by unscrewing the screws halfway.

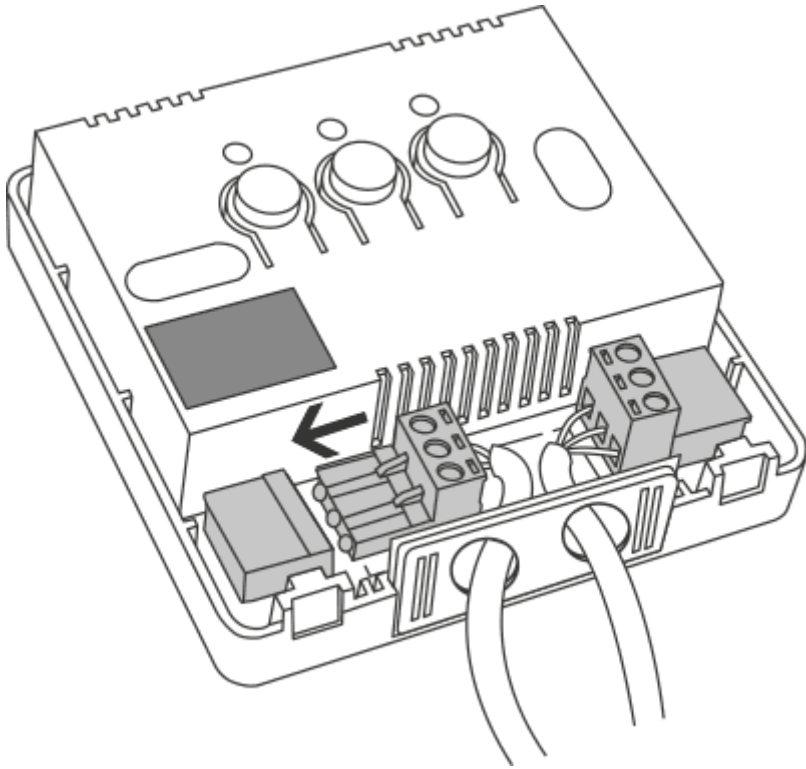

Connect the heating device to the clips of the AURATON Fornax control connector. Follow the service manual of the heating device. COM (common) and NO (normally open circuit) clips are most commonly used.

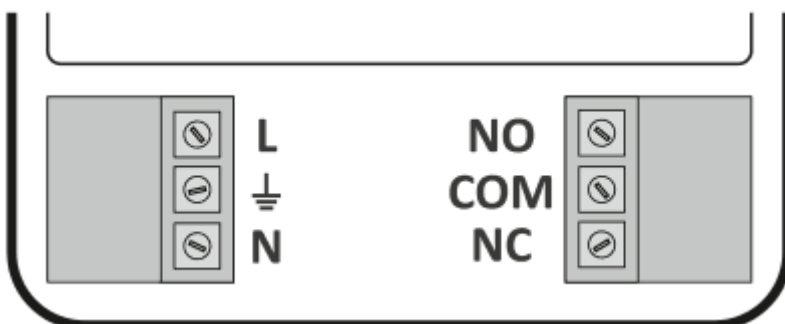

Connect the power supply wires to the clips of the power supply connector of the AURATON Fornax receiver, observing safety rules.

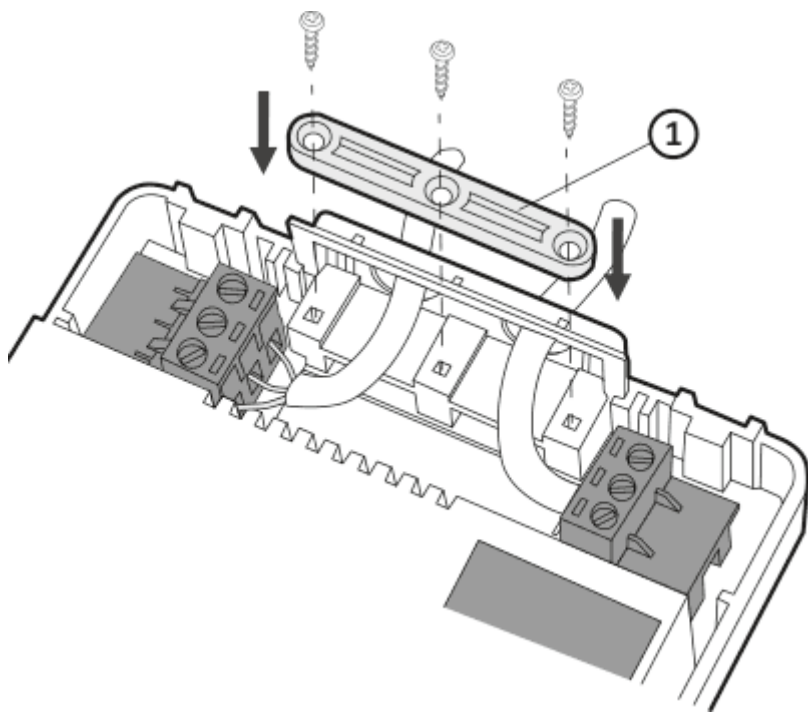

1. Wire mounting bracket.

Once the wires are connected, secure them with the “wire mounting bracket” and screw the cover back onto the AURATON Fornax receiver.

Mounting AURATON Fornax - heating device controller (receiver) onto a wall

To fix AURATON Fornax to a wall:

1. Remove the cover from the front part of the receiver see *chapter "Mounting the AURATON Fornax receiver heating device controller (receiver)"*.
2. Mark the location of the holes for the mounting screws on the wall.
3. Drill holes with diameters of the attached plugs (5 mm) where marked.
4. Insert wall plugs into the drilled holes.
5. Screw the AURATON Fornax receiver to the wall with the screws, so that the device is fixed securely.

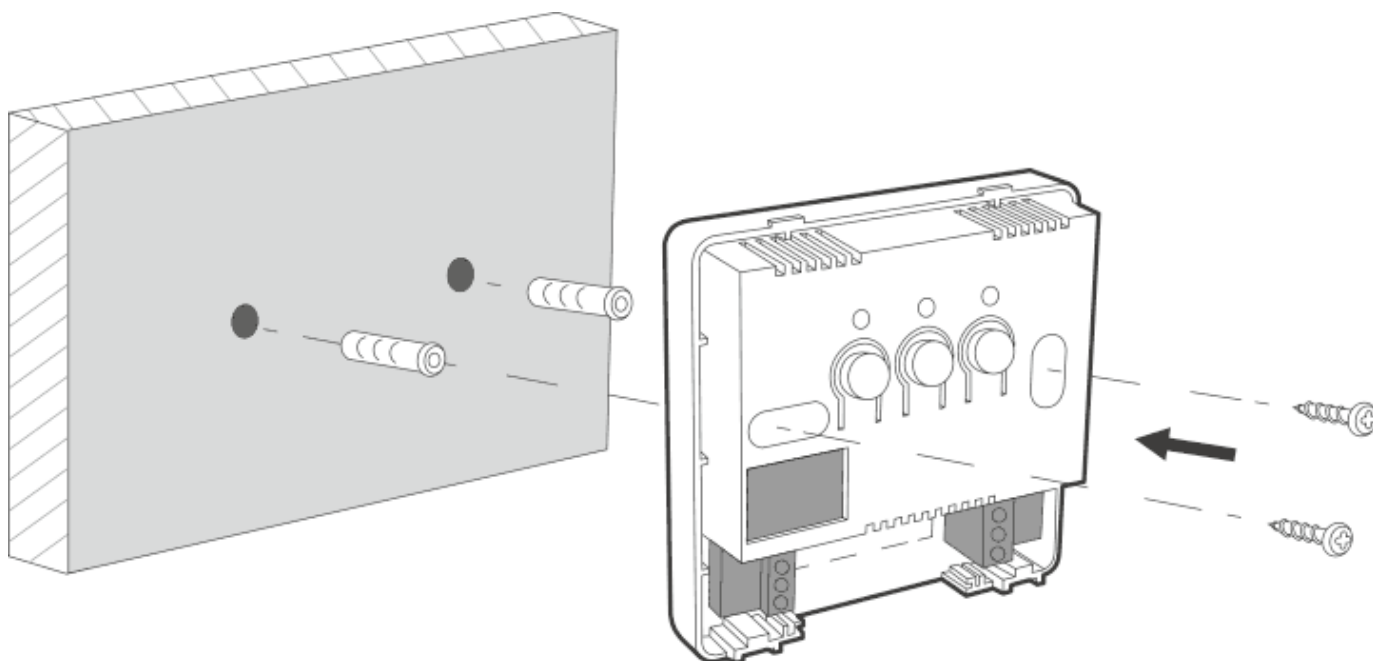

NOTE:

If the wall is wooden, there is no need to use wall plugs. Drill holes with a diameter of 2.7 mm instead of 5 mm and put the screws directly into the wood.

NOTE:

Do not place AURATON Fornax in metal housings (e.g. mounting box, metal housing of a furnace), so as not to interfere with the thermostat's operation.

Pairing

the weekly, wireless thermostat (transmitter) AURATON Tucana R with the wireless heating device controller (receiver) AURATON Fornax.

After connecting to the mains, switch the receiver on by briefly pressing the power button (F). When the device is switched on, the green power diode lights up and there is an audible single sound signal. To switch off the AURATON Fornax e.g. outside the heating season, hold down the power button for 3 seconds until there is an audible double sound signal, and the green power diode switches off, which means that the heating device has also been switched off.

NOTE:

The wireless AURATON Tucana R (transmitter) sold together with the AURATON Fornax wireless heating or air-conditioning device controller (receiver) in the AURATON Tucana SET is already paired. Devices purchased separately require "pairing".

1. To initiate the pairing of AURATON Tucana R (transmitter) with AURATON Fornax, press the right pairing button (D) -- a single sound signal on the AURATON Fornax receiver, and hold it for at least 3 seconds, until the LED diode starts blinking green (double sound signal), then release the button.
The AURATON Fornax receiver will wait 120 seconds for pairing. After this time elapses, it will automatically return to normal operation.
2. Press the **h** button on AURATON Tucana R (transmitter) for 5 seconds until the broadcast symbol (≡) lights up on the display. Release the button - AURATON Tucana R transmits the pairing signal for 5 seconds.
3. Successful completion of pairing is signalled when the green LED diode on the AURATON Fornax receiver is no longer blinking, a single sound signal is heard, and the receiver returns to normal operation.

If there is a pairing error, please repeat steps 1 and 2. In case of further errors, unpair the device by **RESETTING** the AURATON Fornax receiver, see "*RESET - Unpairing a device paired with AURATON*"

Fornax – wireless heating or air-conditioning device controller (receiver)” and trying to pair the devices again.

NOTE:

The Auraton Fornax receiver can be paired with only one AURATON Tucana R.

Signalling the working status and data package reception

Each reception of radio transmission from a paired device is signalled by the AURATON Fornax receiver by a temporary alternating colour change of the LED diodes. When the relay is turned on, the LED diode is red and when the relay is turned off, the LED diode is green.

NOTE:

Pressing a button is signalled by a short sound signal.

Unpairing the weekly, wireless thermostat AURATON Tucana R from AURATON Fornax

1. The unpairing of AURATON Tucana R (the transmitter) from the AURATON Fornax receiver is initiated by pressing the left unpairing button (**E**) on the receiver and holding it for at least 3 seconds until the LED starts blinking red, then release the button. The sound signalling works in the same way as during pairing, i.e. pressing the button is signalled by a short sound followed by a double short sound signal after 3 seconds.
The AURATON Fornax receiver will wait for unpairing from the device for 120 seconds. After this period, it will automatically return to its normal operation.
2. Press and hold the **h** button on the AURATON Tucana R device (transmitter) for 5 seconds until the broadcast symbol (**=**) appears on the display. Release the button.
3. Successful completion of unpairing is signalled when the red LED diode on the AURATON Fornax receiver is no longer blinking, a single sound signal is heard, and the receiver returns to normal

operation.

If there is an unpairing error, please repeat steps 1 and 2. In case of further errors, unpair the paired device, see *“RESET - Unpairing a device paired with AURATON Fornax - wireless heating or air-conditioning device controller (receiver)”*.

RESET - Unpairing a device paired with AURATON Fornax - wireless heating or air-conditioning device (receiver)

In order to unpair a device (e.g. a thermostat) paired with AURATON Fornax, simultaneously press and hold both pairing and unpairing buttons (**D** and **E**) for at least 5 seconds, until the LED diode starts to alternate blinking green - red. Then release both buttons. Sound signals: pressing the button, a short sound signal - after 5 seconds, a double short sound signal.

Successful completion of device unpairing is signalled after about 2 seconds, when the signalling changes to green, and then fades out for a short time.

NOTE:

If you disconnect the AURATON Fornax receiver from the power supply after the RESET and then reconnect the power supply, the receiver will automatically enter the “pairing” mode for 120 seconds. A newly-purchased AURATON Fornax receiver (not purchased together with AURATON Tucana R) without factory-paired devices will behave in the same way.

The RESET function of AURATON Tucana R

Pressing the **RESET** button (•) clears the time and day and restarts AURATON Tucana R.

The MASTER RESET function of AURATON Tucana R

The **MASTER RESET** function restores factory settings. It is activated by pressing the **I** and **RESET (.)** buttons simultaneously.

NOTE:

All user programs will be deleted!

Configuration settings

Configuration settings are set one after another:

changing
the backlight colour



changing
in hysteresis



Offset
change



Clock
calibration

To enter the edit mode of the configuration settings, hold the **b** and **C** buttons simultaneously for 5 seconds until the settings menu is displayed.

Changing the backlight colour

A flashing backlight means that the **bc** buttons can be used to change the backlight colour. Confirm the selection with the **i** button. AURATON Tucana R will go to the next parameter changing mode.



Changes in hysteresis

Hysteresis is supposed to prevent too frequent activation of the actuator due to small temperature fluctuations.

*For example, in the case of **HI 2** hysteresis, when the temperature is set to 20 °C, the boiler will be switched on at 19.8 °C, and switched off at 20.2 °C. In the case of **HI 4** hysteresis, when the temperature is set to 20 °C, the boiler will be switched on at 19.6 °C, and switched off at 20.4 °C.*

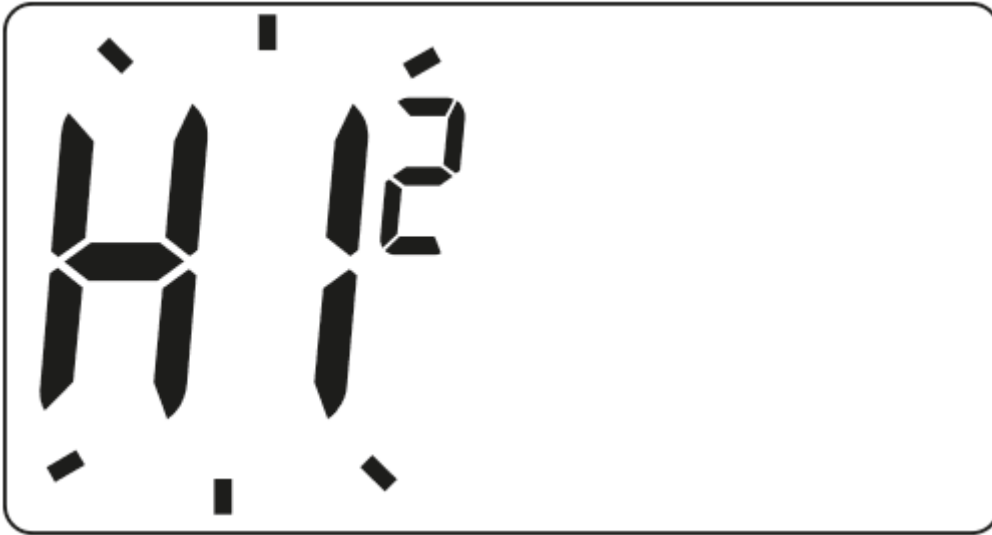

The hysteresis change mode is signaled by a flashing **HI**. Use the **bc** buttons to set the desired hysteresis.

HI 2 - ± 0.2 °C (preset),

HI 4 - ± 0.4 °C,

HI P - PWM operating mode (see chapter "PWM operating mode").

Confirm your choice by pressing the **i** AURATON Tucana R will proceed to change the next parameter.

Offset change

The offset function allows you to calibrate the temperature indications with a tolerance of ± 3 °C. For example, AURATON Tucana R indicates that the room temperature is 23 °C and a standard wall thermometer hanging next to it indicates 24 °C. Changing the offset by +1 degree will make AURATON Tucana R indicate the same temperatures as the wall thermometer.

The offset changing mode is signalled by the flashing text OFFS. Use the **bc** The offset changing mode is signalled by the flashing text OFFS. Use the **i** button. Tucana AURATON will return to its

normal operating mode.



NOTE:

If no button is pressed for 10 seconds while changing the configuration settings, AURATON Tucana R will return to the normal operating mode.

NOTE:

Pressing any function button for the first time always turns on the backlight, and then the function of a specific button.

Clock calibration

This function is used to correct the clock indications in case of any deviations. If the clock is working incorrectly within a week, the extent of incorrect clock indications should be determined. This value should be entered in AURATON Tucana R in the form of seconds.

Example 1:

After a week of operation, AURATON Tucana R shows time accelerated by 1 minute and 20 seconds ($60 + 20 = 80$). In this case you should slow down the clock by setting C -80.

Example 2:

After a week of operation, the clock in AURATON Tucana R is 2 minutes slow ($2 \times 60 = 120$). In this case you should speed up the clock by setting C 120.

NOTE:

The number of seconds should be determined after one week of operation of AURATON Tucana R for the clock calibration function to work correctly (7 days = the number of seconds to be added or subtracted, maximum 294 seconds).

NOTE:

If no button is pressed for 10 seconds while changing the configuration settings, AURATON Tucana R will return to the normal operating mode.

PWM operating mode

(Pulse-Width Modulation)

By changing the hysteresis settings (chapter "Configuration settings"), you can turn on the PWM operating mode. In this mode, AURATON Tucana R cyclically turns on the heating device in order to minimize temperature fluctuations. AURATON Tucana R checks temperature rise times and temperature drop times.

Knowing these values makes AURATON Tucana R turn on and off the heating device in appropriate cycles to maintain the temperature to the set value as close as possible.

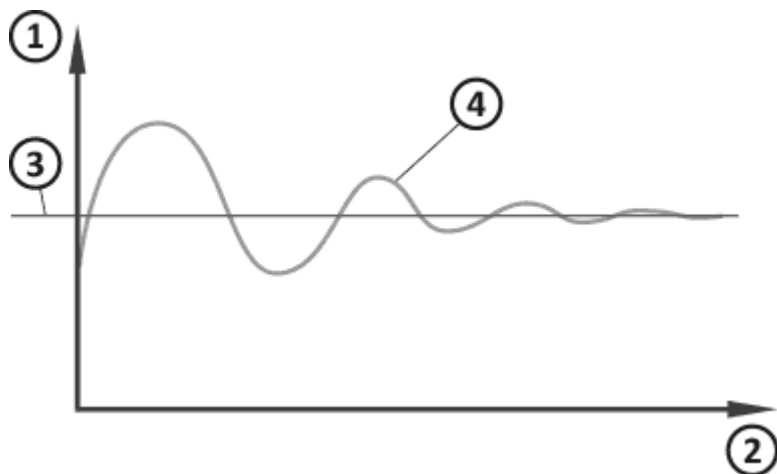

1. Temperature
2. Time
3. Set temperature
4. Room temperature

NOTE:

AURATON Tucana R can turn on the heating device despite the fact that the temperature in the room is higher than the set temperature in the PWM mode. This is caused by the PWM algorithm aiming at maintaining the set temperature and anticipating the behavior of the thermal system.

Special cases

- When 3 consecutive transmissions are lost (after 15 minutes), AURATON Tucana R (transmitter) will signal a malfunction on the AURATON Fornax receiver (the LED diode will alternate blinking red and green). Until the problem is resolved, the receiver will enter the stored on/off cycle from the last 24 hours.
- When the signal from AURATON Tucana R returns, the error is cleared and the AURATON Fornax

receiver returns to normal operation.

Unique features of AURATON Fornax

- Relay switching is synchronised with the 230 V AC power supply line so that the closing and opening of the relay armature contacts always occurs in the area of the voltage waveform reaching zero. This prevents the formation of an electric arc and significantly extends the life of the relay.
- The AURATON Fornax receiver is equipped with a unique algorithm for analysing the on/off cycles. The entire heating cycle from the last 24 hours is stored in AURATON Fornax memory. In the event of loss of communication with the AURATON wireless thermostat (transmitter), AURATON Fornax will automatically execute the stored on/off cycle from the last 24 hours. This gives you time to restore the transmission (solve issues with interference) or repair the thermostat without a significant deterioration of the thermal comfort in the controlled facility.

Additional remarks

- AURATON Tucana R (transmitter) must be installed at least 1 metre away from the receiver (too strong a signal from the transmitter may cause interference).
- At least 30 seconds must elapse between switching the relay off and on again.
- Data from AURATON Tucana R (transmitter) is transmitted to the AURATON Fornax receiver every time the ambient temperature changes by 0.2 °C. If the temperature does not change, AURATON Tucana R transmits control data every 5 minutes (this is signalled by a blinking orange diode on the receiver).
- In the event of a power failure, the AURATON Fornax receiver will switch off. After power is restored, the heating device will automatically switch on, and the AURATON Fornax receiver will wait for a signal from the paired AURATON Tucana R (transmitter) no longer than 5 minutes after power is restored. After receiving the signal, the AURATON Fornax receiver will return to normal operation.
- Placing the AURATON Fornax receiver in a metal housing (e.g. mounting box, metal housing of a furnace) will cause interference with the operation of AURATON Tucana R.

Diagram of connection of AURATON Fornax

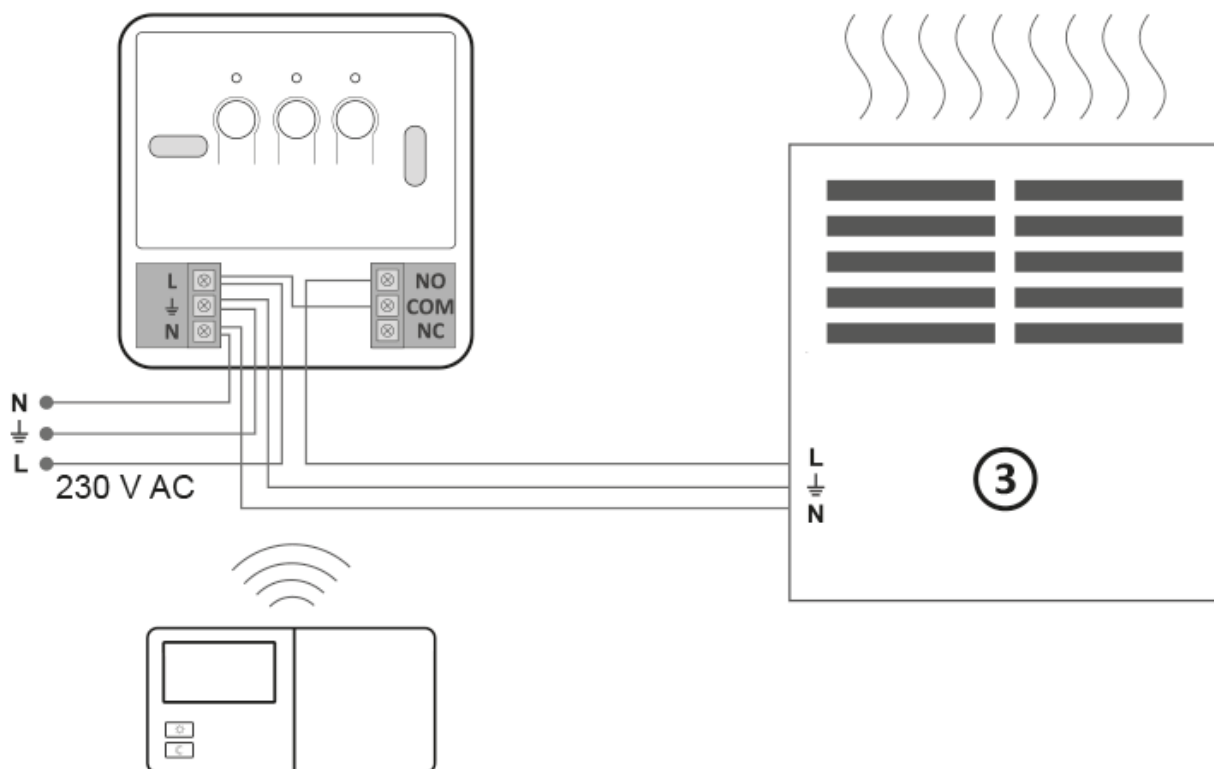
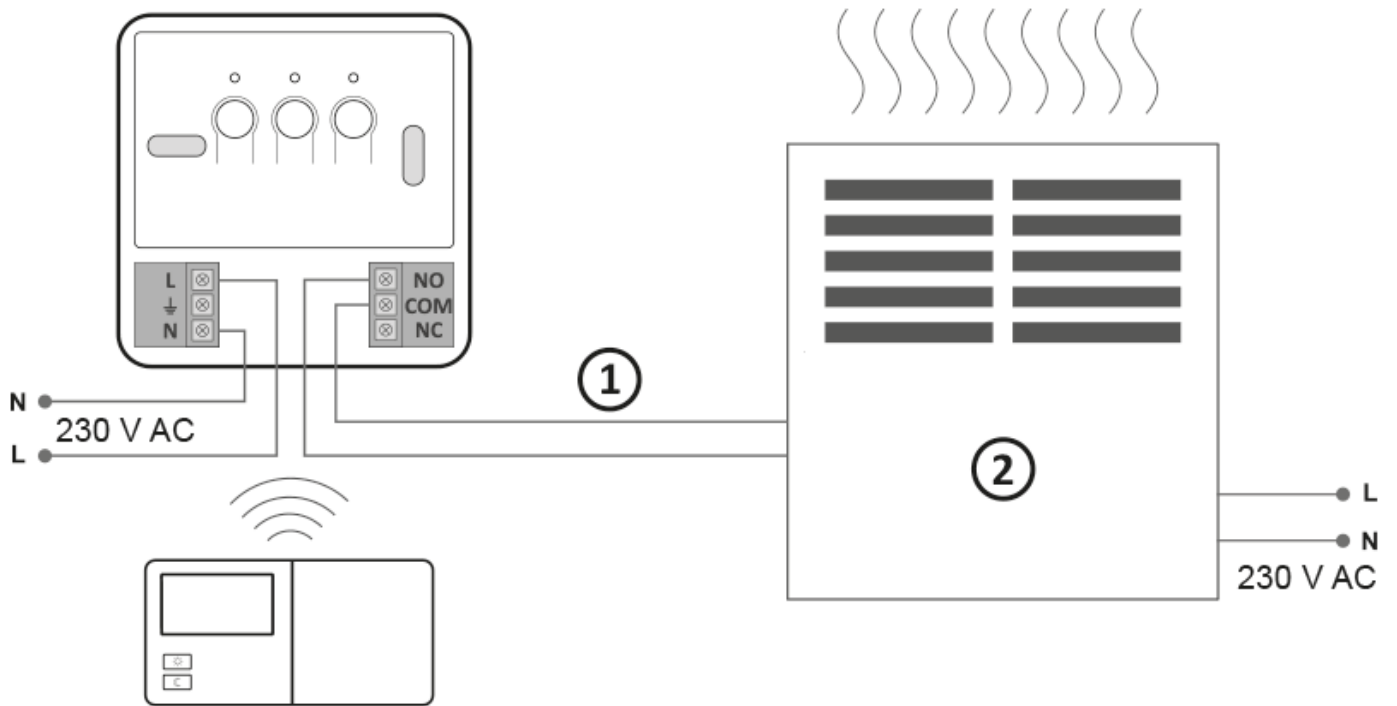

1. Control
2. Heating device *e.g. a gas furnace*
3. Electric heating device

Cleaning and maintenance

- The outside part the device should be cleaned with a dry cloth. Do not use solvents (such as benzene, thinner or alcohol).
- Do not touch the device when your hands are wet. It may cause electric shock or serious damage to the device.
- Do not expose the device to excessive smoke or dust.
- Do not touch the screen with a sharp object.
- Keep the device away from liquids or moisture.

Technical specifications

Working temperature range:	0 - 45 °C
Operation range:	in a typical building with standard wall construction - approx. 30 m; in open space - up to 300 m
Radio frequency:	868.850 MHz 869.000 MHz
Radio signal strength:	Up to 11 dBm
Level of security:	IP20

AURATON Tucana R:

Power supply:	2 x AA (2 x 1.5 V), alkaline
Number of temperature levels:	4
Anti-freeze temperature:	4 - 10 °C

Temperature control range:	5 – 30 °C
Hysteresis:	±0.2 °C/±0.4 °C/PWM
Working cycles::	Weekly programmable
Signalling the working status:	LCD display
Dimensions [mm]:	155 x 80 x 25

AURATON Fornax:

Power supply:	230 V AC, 50 Hz, 1.5 W
Working status signaling:	LED indicators, sound
Relay load capacity	Max. 250 V AC, max. 16 A
Receiver Category:	2
Suggested installation location:	Near the heating device
Dimensions [mm]: [mm]:	100 x 100 x 29

Disposing of the devices

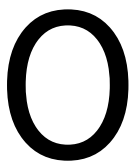

The devices are marked with the crossed-out wheeled bin. According to European Directive 2012/19/EU and the Waste Electrical and Electronic Equipment Act, this kind of marking indicates that the equipment, after its operational life must not be disposed of together with other waste from households.

The user shall return it to a collection point for electrical and electronic waste.

Hereby, LARS Andrzej Szymanski declares that the radio equipment type AURATON Pavo SET is in compliance with Directive 2014/53/EU and 2011/65/EU. The full text of the EU declaration of conformity is available below in the download area.

Contact and address of the manufacturer:

LARS, ul. Świerkowa 14

Download

- [User manual](#)
- [AURATON Tucana R declaration of conformity](#)
- [AURATON Fornax declaration of conformity](#)