





	T5019W0	BIAŁA		0 - * - 5	* - 5		M30x1.5
	T5029W0	CHROM	•	•			M30x1.5
	T5019	BIAŁA	•		•		M30x1.5
	T5029	CHROM	•		•		M30x1.5
	T5019DAW0	BIAŁA			•		typ RA
	T5019DA	BIAŁA				•	typ RA

	0	*	1	2	3	4	5
°C	1	6	14	18	21	24	28

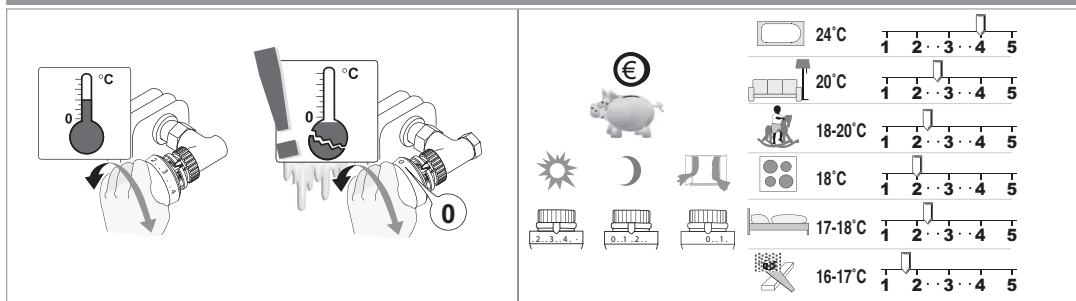
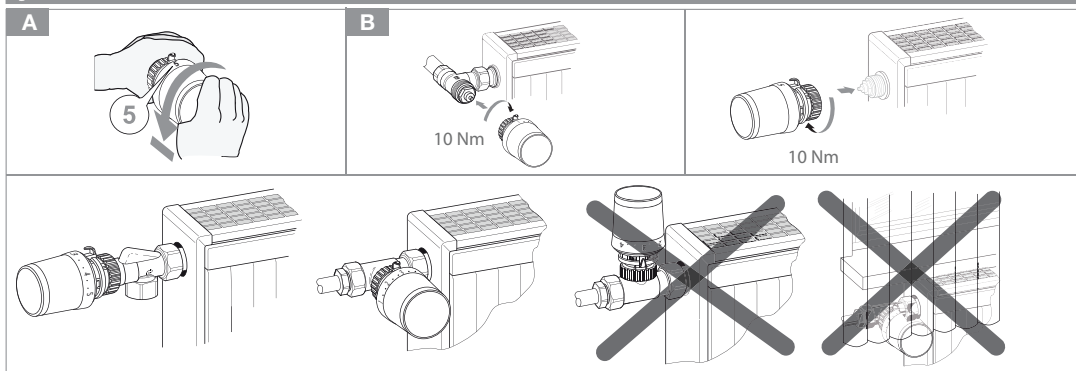

			
	VA8210A001		TA1000A001 TA1000A002
			TA6900A001

**Więcej informacji
znajduje się na stronie:**
resideo.com/pl/pl



Ademco Sp. z o.o.
ul. Domaniewska 39
02-672 Warszawa
wsparcie@resideo.com
m.resideo.com/pl/pl

Doc. | Rev | 04/20
Podane informacje mogą ulec zmianie
bez powiadomienia.
© 2020 Resideo Technologies, Inc. Nazwa
Honeywell Home jest znakiem towarowym
spółki Honeywell International Inc.,
używanym na licencji udzielonej firmie
Resideo Technologies, Inc.

Honeywell Home