



Scambiatori: tabella compatibilità - *Heat exchangers: compatibility list*



WHEN QUALITY COMES FIRST



indice | *index*

ARCA*	4
ARISTON*- MTS*	5
ATAG*	6
BAXI* - OCEAN*	7
BERETTA*	8
BIASI* - SAVIO* - BSG*	9
BOSCH*	10
BROTJE*	10
CHAFFOTEAUX*	11
ECOFLAM*	13
ELM LEBLANC*	13
FAGOR*	14
FERROLI*	15
FONDERIE SIME*	16
FONDITAL*	17
FONTICAL*	18
GRANT*	18
GRUPPO IMAR*	19
HERMANN*	19
IMMERGAS*	20
JUNKERS*	22
LAMBORGHINI*	23
RADIANT*	23
RAVENHEAT*	24
RIELLO*	24
SAUNIER DUVAL*	25
SILE*	25
TURK DEMIR DUKUM*	26
UNICAL*	27
VAILLANT*	28

* i marchi menzionati nel presente opuscolo appartengono ai legittimi proprietari e sono utilizzati al solo ed esclusivo scopo di descrivere l'applicazione e la compatibilità degli scambiatori inseriti

** trademarks mentioned in this publication belong to their respective owners and are used for the sole and exclusive purpose of describing the application and compatibility of the heat exchangers included*



ZB 190

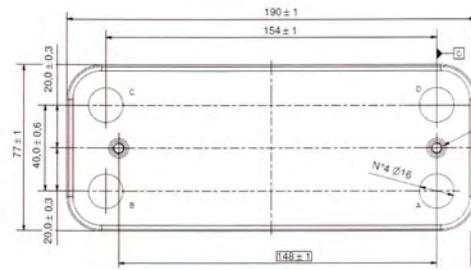

Applicazione tipo - <i>Typical application</i>		ARCA	
Tipo attacco - <i>Way of connection</i>		O-RING	
Caratteristiche - <i>Features</i>		Interasse fori - <i>Holes distance</i> : 154 x 40 mm Interasse prigionieri - <i>Studs distance</i> : 148 mm	
N° piastre <i>Nr. of plates</i>	Codice generico <i>General code</i>	Imballo singolo <i>Individual packaging</i>	Imballo 5 pz <i>5-piece packaging</i>
12	17B1901200	17S1901200	17M1901200
14	17B1901400	17S1901400	17M1901400
16	17B1901600	17S1901600	17M1901600

ZB 190

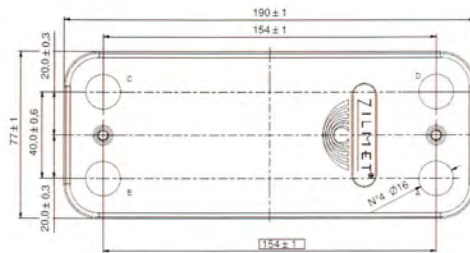

Applicazione tipo - <i>Typical application</i>		ARCA	
Tipo attacco - <i>Way of connection</i>		O-RING	
Caratteristiche - <i>Features</i>		Interasse fori - <i>Holes distance</i> : 154 x 40 mm Interasse prigionieri - <i>Studs distance</i> : 154 mm	
N° piastre <i>Nr. of plates</i>	Codice generico <i>General code</i>	Imballo singolo <i>Individual packaging</i>	Imballo 5 pz <i>5-piece packaging</i>
12	17B1901206	17S1901206	17M1901206
14	17B1901406	17S1901406	17M1901406



Scambiatori a piastre: tabella compatibilità
Heat exchangers: compatibility list



ZB 190

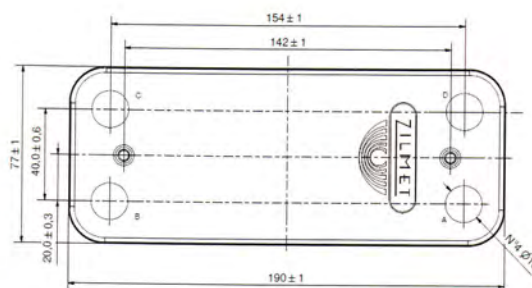

Applicazione tipo - *Typical application*

ARISTON

Tipo attacco - *Way of connection*

O-RING

Caratteristiche - *Features*

Interasse fori - *Holes distance*: 154 x 40 mm
Interasse prigionieri - *Studs distance*: 142 mm

N° piastre <i>Nr. of plates</i>	Codice generico <i>General code</i>	Imballo singolo <i>Individual packaging</i>	Imballo 5 pz <i>5-piece packaging</i>
12	17B1901244	17S1901244	17M1901244
14	17B1901444	17S1901444	17M1901444
16	17B1901644	17S1901644	17M1901644

ZB 207

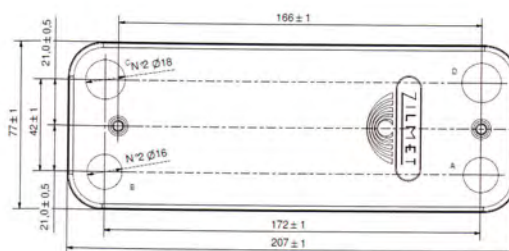

Applicazione tipo - *Typical application*

ARISTON-MTS

Tipo attacco - *Way of connection*

O-RING

Caratteristiche - *Features*

Interasse fori - *Holes distance*: 172 x 42 mm
Interasse prigionieri - *Studs distance*: 166 mm

N° piastre <i>Nr. of plates</i>	Codice generico <i>General code</i>	Imballo singolo <i>Individual packaging</i>	Imballo 5 pz <i>5-piece packaging</i>
12	17B2071206	17S2071206	17M2071206
14	17B2071406	17S2071406	17M2071406
16	17B2071606	17S2071606	17M2071606



Scambiatori a piastre: tabella compatibilità
Heat exchangers: compatibility list



ZB 315

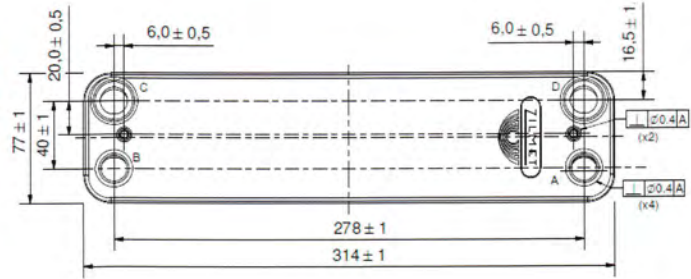

Applicazione tipo - <i>Typical application</i>		ATAG	
Tipo attacco - <i>Way of connection</i>		Innesto - <i>Quick connection</i>	
Caratteristiche - <i>Features</i>		Interasse fori - <i>Holes distance</i> : 278 x 40 mm Interasse prigionieri - <i>Studs distance</i> : 266 mm	
N° piastre <i>Nr. of plates</i>	Codice generico <i>General code</i>	Imballo 3 pz <i>3-piece packaging</i>	
12	17B3151203	17M3151203	
18	17B3151803	17M3151803	

ZB 207

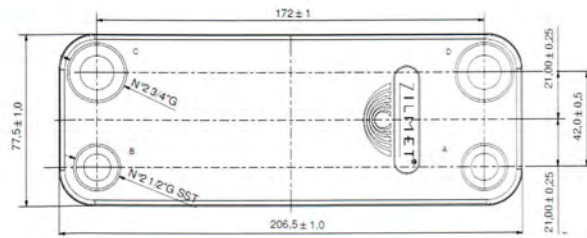

Applicazione tipo - <i>Typical application</i>		ATAG	
Tipo attacco - <i>Way of connection</i>		Filettato - <i>Threaded</i>	
Caratteristiche - <i>Features</i>		Interasse fori - <i>Holes distance</i> : 172 x 42 mm Raccordi - <i>Connections</i> : 2 x 3/4" + 2 x 1/2"	
N° piastre <i>Nr. of plates</i>	Codice generico <i>General code</i>	Imballo singolo <i>Individual packaging</i>	Imballo 5 pz <i>5-piece packaging</i>
16	17B2071607	17S2071607	17M2071607



Scambiatori a piastre: tabella compatibilità
Heat exchangers: compatibility list



ZB 207

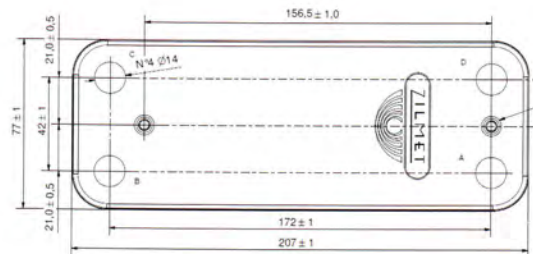

Applicazione tipo - *Typical application*

BAXI

Tipo attacco - *Way of connection*

O-RING

Caratteristiche - *Features*

Interasse fori - *Holes distance*: 172 x 42 mm
Interasse prigionieri - *Studs distance*: 156,5 mm

N° piastre <i>Nr. of plates</i>	Codice generico <i>General code</i>	Imballo singolo <i>Individual packaging</i>	Imballo 5 pz <i>5-piece packaging</i>
10	17T2071000	17ST071000	17MT071000
12	17T2071200	17ST071200	17MT071200
14	17T2071400	17ST071400	17MT071400
20	17T2072000	17ST072000	17MT072000

ZB 207

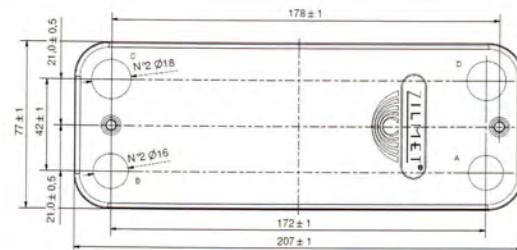

Applicazione tipo - *Typical application*

BAXI (OCEAN)

Tipo attacco - *Way of connection*

O-RING

Caratteristiche - *Features*

Interasse fori - *Holes distance*: 172 x 42 mm
Interasse prigionieri - *Studs distance*: 178 mm

N° piastre <i>Nr. of plates</i>	Codice generico <i>General code</i>	Imballo singolo <i>Individual packaging</i>	Imballo 5 pz <i>5-piece packaging</i>
12	17B2071201	17S2071201	17M2071201
14	17B2071401	17S2071401	17M2071401
16	17B2071601	17S2071601	17M2071601



Scambiatori a piastre: tabella compatibilità
Heat exchangers: compatibility list



ZB 207

NEW

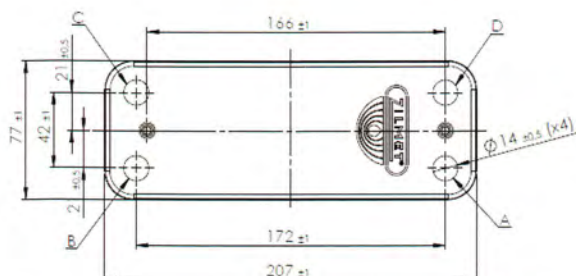

Applicazione tipo - *Typical application*

BAXI

Tipo attacco - *Way of connection*

O-RING

Caratteristiche - *Features*

Interasse fori - *Holes distance*: 172 x 42 mm
Interasse prigionieri - *Studs distance*: 166 mm

N° piastre <i>Nr. of plates</i>	Codice generico <i>General code</i>	Imballo singolo <i>Individual packaging</i>	Imballo 5 pz <i>5-piece packaging</i>
10	17T2071006	17ST071006	17MT071006
12	17T2071206	17ST071206	17MT071206
14	17T2071406	17ST071406	17MT071406
20	17T2072006	17ST072006	17MT072006

ZB 190

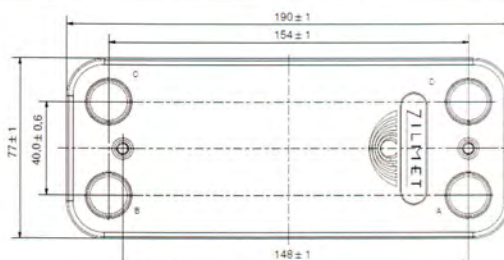

Applicazione tipo - *Typical application*

BERETTA

Tipo attacco - *Way of connection*

O-RING

Caratteristiche - *Features*

Interasse fori - *Holes distance*: 154 x 40 mm
Interasse prigionieri - *Studs distance*: 148 mm

N° piastre <i>Nr. of plates</i>	Codice generico <i>General code</i>	Imballo singolo <i>Individual packaging</i>	Imballo 5 pz <i>5-piece packaging</i>
12	17B1901201	17S1901201	17M1901201
14	17B1901401	17S1901401	17M1901401
16	17B1901601	17S1901601	17M1901601



Scambiatori a piastre: tabella compatibilità
Heat exchangers: compatibility list



ZB 190

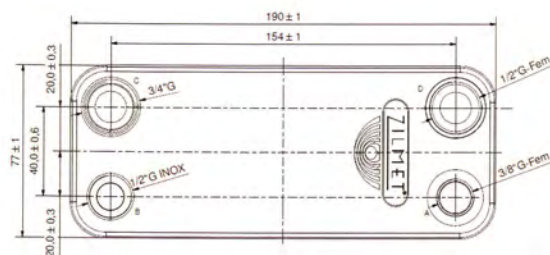

Applicazione tipo - *Typical application*

BERETTA

Tipo attacco - *Way of connection*

Filettato - *Threaded*

Caratteristiche - *Features*

Interasse fori - *Holes distance*: 154 x 40 mm
Raccordi - *Connections*: 1 x 3/4" + 2 x 1/2" + 1 x 3/8"

N° piastre <i>Nr. of plates</i>	Codice generico <i>General code</i>	Imballo singolo <i>Individual packaging</i>	Imballo 5 pz <i>5-piece packaging</i>
12	17B1901203	17S1901203	17M1901203
14	17B1901403	17S1901403	17M1901403
16	17B1901603	17S1901603	17M1901603

ZB 190

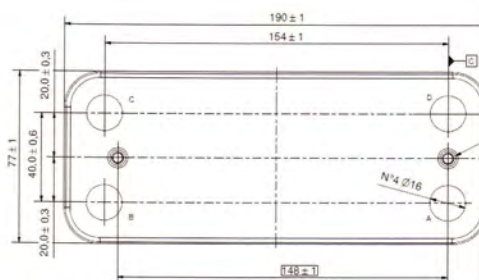

Applicazione tipo - *Typical application*

BIASI-SAVIO (BSG)

Tipo attacco - *Way of connection*

O-RING

Caratteristiche - *Features*

Interasse fori - *Holes distance*: 154 x 40 mm
Interasse prigionieri - *Studs distance*: 148 mm

N° piastre <i>Nr. of plates</i>	Codice generico <i>General code</i>	Imballo singolo <i>Individual packaging</i>	Imballo 5 pz <i>5-piece packaging</i>
12	17B1901200	17S1901200	17M1901200
14	17B1901400	17S1901400	17M1901400
16	17B1901600	17S1901600	17M1901600



Scambiatori a piastre: tabella compatibilità
Heat exchangers: compatibility list



ZB 207

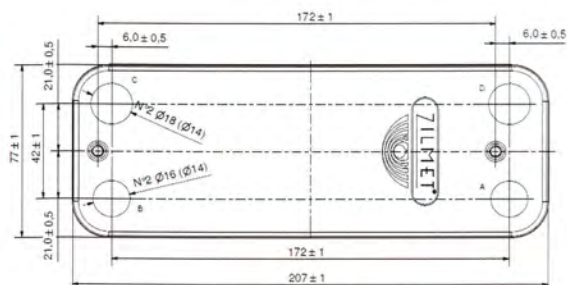

Applicazione tipo - *Typical application*

BOSCH

Tipo attacco - *Way of connection*

O-RING

Caratteristiche - *Features*

Interasse fori - *Holes distance*: 72 x 42 mm
Interasse prigionieri - *Studs distance*: 172 mm

N° piastre <i>Nr. of plates</i>	Codice generico <i>General code</i>	Imballo singolo <i>Individual packaging</i>	Imballo 5 pz <i>5-piece packaging</i>
14	17B2071432	17S2071432	17M2071432

ZB 207

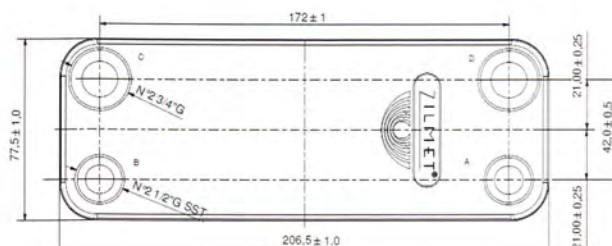

Applicazione tipo - *Typical application*

BROTJE

Tipo attacco - *Way of connection*

Filettato - *Threaded*

Caratteristiche - *Features*

Interasse fori - *Holes distance*: 172 x 42 mm
Raccordi - *Connections*: 2 x 3/4" + 2 x 1/2"

N° piastre <i>Nr. of plates</i>	Codice generico <i>General code</i>	Imballo singolo <i>Individual packaging</i>	Imballo 5 pz <i>5-piece packaging</i>
20	17B2072007	17S2072007	17M2072007



Scambiatori a piastre: tabella compatibilità
Heat exchangers: compatibility list



ZB 195

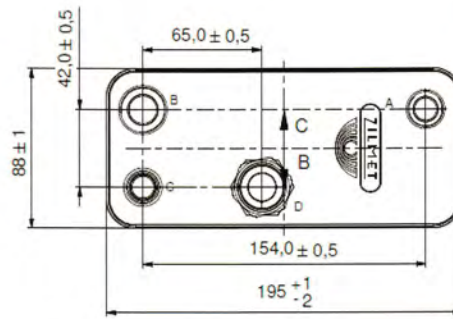

Applicazione tipo - Typical application

BROTJE

Tipo attacco - Way of connection

Filettato - Threaded

Caratteristiche - Features

Interasse fori - Holes distance: 154 x 42 mm
Raccordi - Connections: 2 x 3/4" + 1 x 1/2" + 1 quick c.

N° piastre Nr. of plates	Codice generico General code	Imballo singolo Individual packaging	Imballo 4 pz 4-piece packaging
15	17B1951501	17S1951501	17M1951501

ZB 207

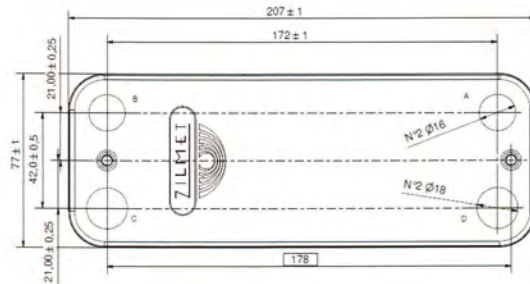

Applicazione tipo - Typical application

CHAFFOTEAUX

Tipo attacco - Way of connection

O-RING

Caratteristiche - Features

Interasse fori - Holes distance: 172 x 42 mm
Interasse prigionieri - Studs distance: 178 mm

N° piastre Nr. of plates	Codice generico General code	Imballo singolo Individual packaging	Imballo 5 pz 5-piece packaging
12	17B2071210	17S2071210	17M2071210
14	17B2071410	17S2071410	17M2071410
16	17B2071610	17S2071610	17M2071610



Scambiatori a piastre: tabella compatibilità
Heat exchangers: compatibility list



ZB 190

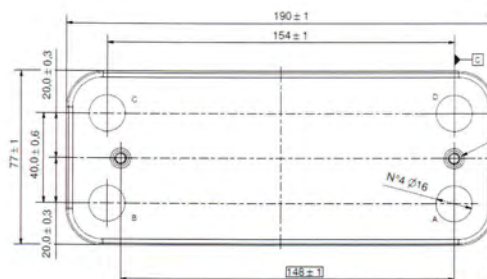

Applicazione tipo - Typical application

CHAFFOTEAUX

Tipo attacco - Way of connection

O-RING

Caratteristiche - Features

Interasse fori - Holes distance: 154 x 40 mm
Interasse prigionieri - Studs distance: 148 mm

N° piastre Nr. of plates	Codice generico General code	Imballo singolo Individual packaging	Imballo 5 pz 5-piece packaging
14	17B1901400	17S1901400	17M1901400

ZB 190

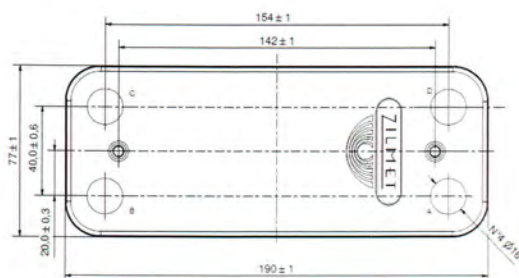

Applicazione tipo - Typical application

CHAFFOTEAUX

Tipo attacco - Way of connection

O-RING

Caratteristiche - Features

Interasse fori - Holes distance: 154 x 40 mm
Interasse prigionieri - Studs distance: 142 mm

N° piastre Nr. of plates	Codice generico General code	Imballo singolo Individual packaging	Imballo 5 pz 5-piece packaging
14	17B1901444	17S1901444	17M1901444
16	17B1901644	17S1901644	17M1901644



Scambiatori a piastre: tabella compatibilità
Heat exchangers: compatibility list



ZB 207

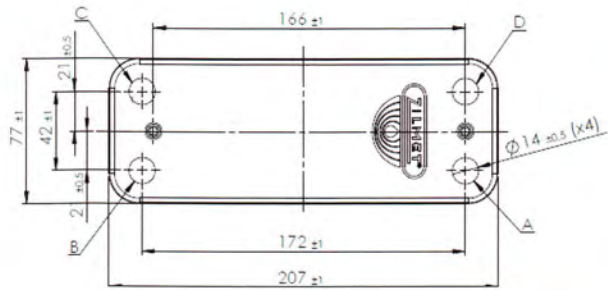

Applicazione tipo - <i>Typical application</i>		ECOFLAM	
Tipo attacco - <i>Way of connection</i>		O-RING	
Caratteristiche - <i>Features</i>		Interasse fori - <i>Holes distance</i> : 172 x 42 mm Interasse prigionieri - <i>Studs distance</i> : 166 mm	
N° piastre <i>Nr. of plates</i>	Codice generico <i>General code</i>	Imballo singolo <i>Individual packaging</i>	Imballo 5 pz <i>5-piece packaging</i>
16	17T2071606	17ST071606	17MT071606

ZB 190

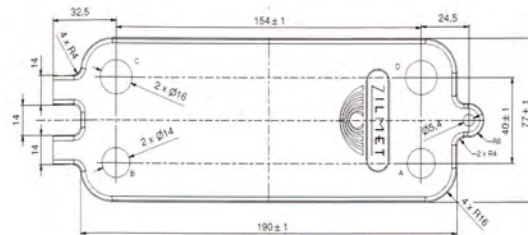

Applicazione tipo - <i>Typical application</i>		E.L.M. LEBLANC	
Tipo attacco - <i>Way of connection</i>		O-RING	
Caratteristiche - <i>Features</i>		Interasse fori - <i>Holes distance</i> : 154 x 40 mm Interasse prigionieri - <i>Studs distance</i> : -----	
N° piastre <i>Nr. of plates</i>	Codice generico <i>General code</i>	Imballo singolo <i>Individual packaging</i>	Imballo 5 pz <i>5-piece packaging</i>
24	17B1902433	17S1902433	17M1902433



Scambiatori a piastre: tabella compatibilità
Heat exchangers: compatibility list



ZB 207

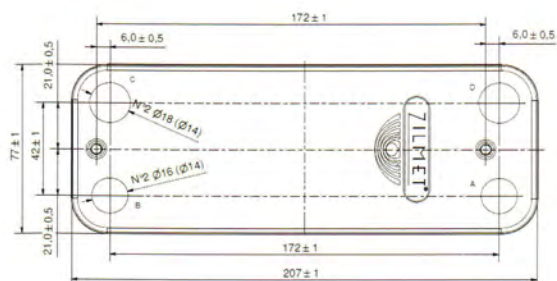

Applicazione tipo - <i>Typical application</i>		E.L.M. LEBLANC	
Tipo attacco - <i>Way of connection</i>		O-RING	
Caratteristiche - <i>Features</i>		Interasse fori - <i>Holes distance</i> : 172 x 42 mm Interasse prigionieri - <i>Studs distance</i> : 172 mm	
N° piastre <i>Nr. of plates</i>	Codice generico <i>General code</i>	Imballo singolo <i>Individual packaging</i>	Imballo 5 pz <i>5-piece packaging</i>
14	17B2071432	17S2071432	17M2071432

ZB 195

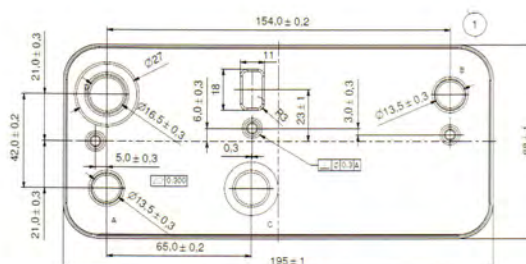

Applicazione tipo - <i>Typical application</i>		FAGOR	
Tipo attacco - <i>Way of connection</i>		O-RING	
Caratteristiche - <i>Features</i>		Interasse fori - <i>Holes distance</i> : 154 x 42 mm Interasse prigionieri - <i>Studs distance</i> : 159 / 65 mm	
N° piastre <i>Nr. of plates</i>	Codice generico <i>General code</i>	Imballo singolo <i>Individual packaging</i>	Imballo 4 pz <i>4-piece packaging</i>
13	17B1951321	17S1951321	17M1951321



Scambiatori a piastre: tabella compatibilità
Heat exchangers: compatibility list



ZB 190

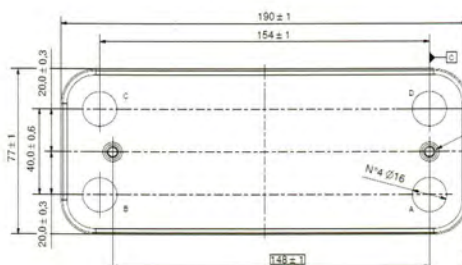

Applicazione tipo - *Typical application*

FERROLI

Tipo attacco - *Way of connection*

O-RING

Caratteristiche - *Features*

Interasse fori - *Holes distance*: 154 x 40 mm

Interasse prigionieri - *Studs distance*: 148 mm

N° piastre <i>Nr. of plates</i>	Codice generico <i>General code</i>	Imballo singolo <i>Individual packaging</i>	Imballo 5 pz <i>5-piece packaging</i>
16	17B1901600	17S1901600	17M1901600
20	17B1902000	17S1902000	17M1902000

ZB 190

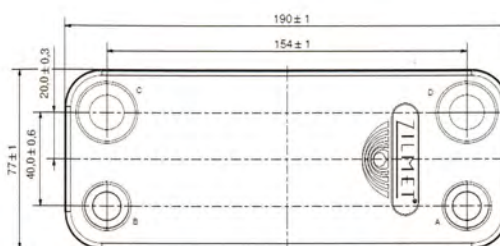

Applicazione tipo - *Typical application*

FERROLI

Tipo attacco - *Way of connection*

Filettato - *Threaded*

Caratteristiche - *Features*

Interasse fori - *Holes distance*: 154 x 40 mm

Raccordi - *Connections*: 2 x 3/4" + 2 x 1/2"

N° piastre <i>Nr. of plates</i>	Codice generico <i>General code</i>	Imballo singolo <i>Individual packaging</i>	Imballo 5 pz <i>5-piece packaging</i>
16	17B1901605	17S1901605	17M1901605
20	17B1902005	17S1902005	17M1902005



Scambiatori a piastre: tabella compatibilità
Heat exchangers: compatibility list



ZB 195

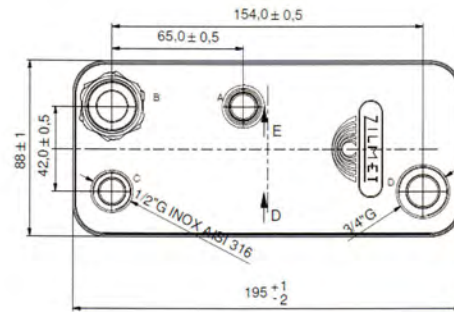

Applicazione tipo - Typical application

FONDERIE SIME

Tipo attacco - Way of connection

Filettato - Threaded

Caratteristiche - Features

Interasse fori - Holes distance: 154 x 42 mm
Raccordi - Connections: 2 x 3/4" + 1 x 1/2" + 1 quick c.

N° piastre Nr. of plates	Codice generico General code	Imballo singolo Individual packaging	Imballo 4 pz 4-piece packaging
14	17B1951400	17S1951400	17M1951400

ZB 195

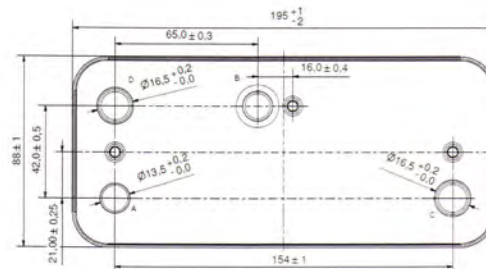

Applicazione tipo - Typical application

FONDERIE SIME

Tipo attacco - Way of connection

O-RING

Caratteristiche - Features

Interasse fori - Holes distance: 154 x 42 mm
Interasse prigionieri - Studs distance: 154 / 71 mm

N° piastre Nr. of plates	Codice generico General code	Imballo singolo Individual packaging	Imballo 4 pz 4-piece packaging
14	17B1951409	17S1951409	17M1951409



Scambiatori a piastre: tabella compatibilità
Heat exchangers: compatibility list



ZA 190

NEW

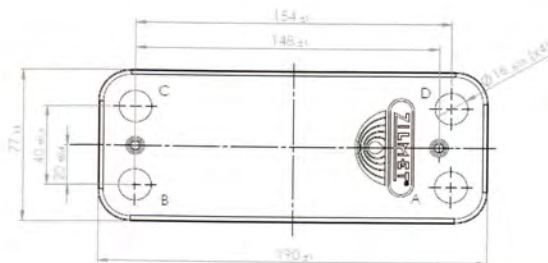

Applicazione tipo - Typical application

FONDERIE SIME

Tipo attacco - Way of connection

O-RING

Caratteristiche - Features

Interasse fori - Holes distance: 154 x 40 mm
Interasse prigionieri - Studs distance: 148 mm

N° piastre Nr. of plates	Codice generico General code	Imballo singolo Individual packaging	Imballo 5 pz 5-piece packaging
12	17A1901210	17SA901210	17MA901210
14	17A1901410	17SA901410	17MA901410
16	17A1901610	17SA901610	17MA901610

ZB 207

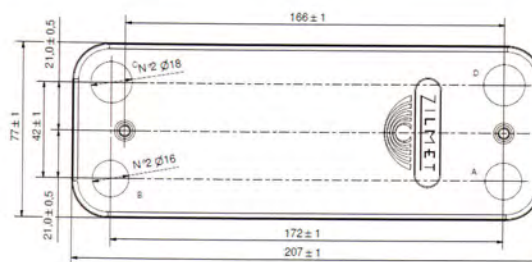

Applicazione tipo - Typical application

FONDITAL

Tipo attacco - Way of connection

O-RING

Caratteristiche - Features

Interasse fori - Holes distance: 172 x 42 mm
Interasse prigionieri - Studs distance: 166 mm

N° piastre Nr. of plates	Codice generico General code	Imballo singolo Individual packaging	Imballo 5 pz 5-piece packaging
14	17B2071406	17S2071406	17M2071406



Scambiatori a piastre: tabella compatibilità
Heat exchangers: compatibility list



ZB 190

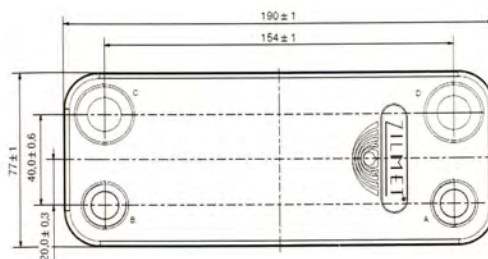

Applicazione tipo - <i>Typical application</i>		FONTECAL	
Tipo attacco - <i>Way of connection</i>		Filettato - <i>Threaded</i>	
Caratteristiche - <i>Features</i>		Interasse fori - <i>Holes distance</i> : 154 x 40 mm Raccordi - <i>Connections</i> : 2 x 3/4" + 2 x 1/2"	
N° piastre <i>Nr. of plates</i>	Codice generico <i>General code</i>	Imballo singolo <i>Individual packaging</i>	Imballo 5 pz <i>5-piece packaging</i>
14	17B1901402	17S1901402	17M1901402

ZB 195

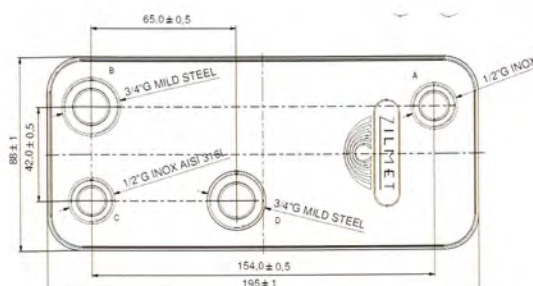

Applicazione tipo - <i>Typical application</i>		GRANT	
Tipo attacco - <i>Way of connection</i>		Filettato - <i>Threaded</i>	
Caratteristiche - <i>Features</i>		Interasse fori - <i>Holes distance</i> : 154 x 42 mm Raccordi - <i>Connections</i> : 2 x 3/4" + 2 x 1/2"	
N° piastre <i>Nr. of plates</i>	Codice generico <i>General code</i>	Imballo singolo <i>Individual packaging</i>	Imballo 4 pz <i>4-piece packaging</i>
35	17B1953553	17S1953553	17M1953553



Scambiatori a piastre: tabella compatibilità
Heat exchangers: compatibility list



ZB 315

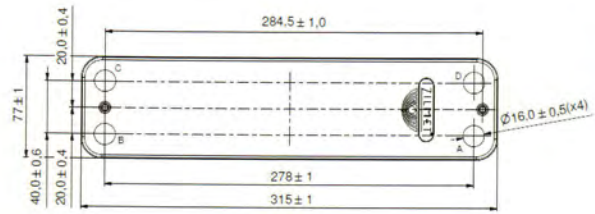

Applicazione tipo - *Typical application*

GRUPPO IMAR

Tipo attacco - *Way of connection*

O-RING

Caratteristiche - *Features*

Interasse fori - *Holes distance*: 278 x 40 mm
Interasse prigionieri - *Studs distance*: 284,5 mm

N° piastre <i>Nr. of plates</i>	Codice generico <i>General code</i>	Imballo 3 pz <i>3-piece packaging</i>
12	17B3151200	17M3151200
16	17B3151600	17M3151600

ZB 195

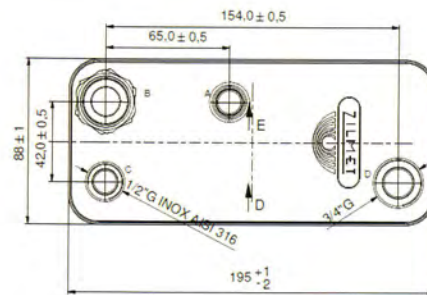

Applicazione tipo - *Typical application*

HERMANN

Tipo attacco - *Way of connection*

Filettato - *Threaded*

Caratteristiche - *Features*

Interasse fori - *Holes distance*: 154 x 42 mm
Raccordi - *Connections*: 2 x 3/4" + 1 x 1/2" + 1 quick c.

N° piastre <i>Nr. of plates</i>	Codice generico <i>General code</i>	Imballo singolo <i>Individual packaging</i>	Imballo 4 pz <i>4-piece packaging</i>
12	17B1951200	17S1951200	17M1951200
14	17B1951400	17S1951400	17M1951400



Scambiatori a piastre: tabella compatibilità
Heat exchangers: compatibility list



ZB 195

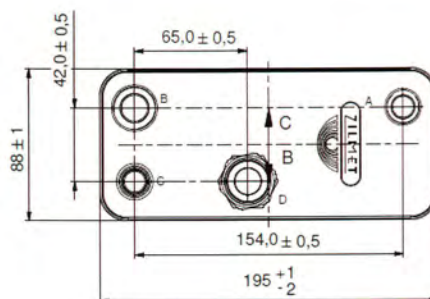

Applicazione tipo - *Typical application*

IMMERGAS

Tipo attacco - *Way of connection*

Filettato - *Threaded*

Caratteristiche - *Features*

Interasse fori - *Holes distance*: 154 x 42 mm
Raccordi - *Connections*: 2 x 3/4" + 1 x 1/2" + 1 quick c.

N° piastre <i>Nr. of plates</i>	Codice generico <i>General code</i>	Imballo singolo <i>Individual packaging</i>	Imballo 4 pz <i>4-piece packaging</i>
15	17B1951501	17S1951501	17M1951501

ZB 195

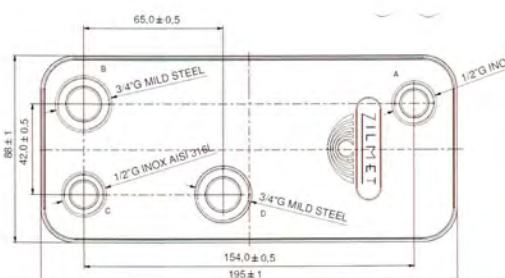

Applicazione tipo - *Typical application*

IMMERGAS

Tipo attacco - *Way of connection*

Filettato - *Threaded*

Caratteristiche - *Features*

Interasse fori - *Holes distance*: 154 x 42 mm
Raccordi - *Connections*: 2 x 3/4" + 2 x 1/2"

N° piastre <i>Nr. of plates</i>	Codice generico <i>General code</i>	Imballo singolo <i>Individual packaging</i>	Imballo 4 pz <i>4-piece packaging</i>
13	17B1951302	17S1951302	17M1951302
15	17B1951502	17S1951502	17M1951502
17	17B1951702	17S1951702	17M1951702



Scambiatori a piastre: tabella compatibilità
Heat exchangers: compatibility list



ZB 200

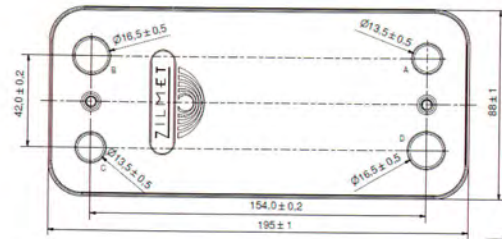

Applicazione tipo - <i>Typical application</i>		IMMERGAS	
Tipo attacco - <i>Way of connection</i>		O-RING	
Caratteristiche - <i>Features</i>		Interasse fori - <i>Holes distance</i> : 154 x 42 mm Interasse prigionieri - <i>Studs distance</i> : 154 mm	
N° piastre <i>Nr. of plates</i>	Codice generico <i>General code</i>	Imballo singolo <i>Individual packaging</i>	Imballo 4 pz <i>4-piece packaging</i>
16	17B2001600	17S2001600	17M2001600
20	17B2002000	17S2002000	17M2002000

ZB 190

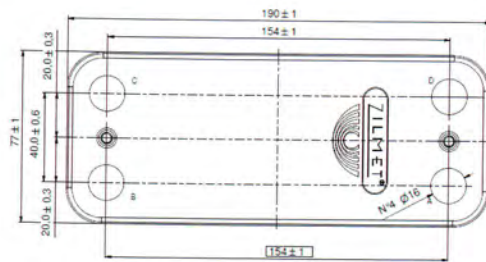

Applicazione tipo - <i>Typical application</i>		IMMERGAS	
Tipo attacco - <i>Way of connection</i>		O-RING	
Caratteristiche - <i>Features</i>		Interasse fori - <i>Holes distance</i> : 154 x 40 mm Interasse prigionieri - <i>Studs distance</i> : 154 mm	
N° piastre <i>Nr. of plates</i>	Codice generico <i>General code</i>	Imballo singolo <i>Individual packaging</i>	Imballo 5 pz <i>5-piece packaging</i>
12	17B1901206	17S1901206	17M1901206
16	17B1901606	17S1901606	17M1901606
20	17B1902006	17S1902006	17M1902006



Scambiatori a piastre: tabella compatibilità
Heat exchangers: compatibility list



ZB 190

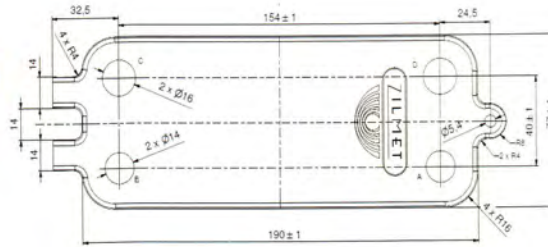

Applicazione tipo - <i>Typical application</i>		JUNKERS	
Tipo attacco - <i>Way of connection</i>		O-RING	
Caratteristiche - <i>Features</i>		Interasse fori - <i>Holes distance</i> : 154 x 40 mm Interasse prigionieri - <i>Studs distance</i> : -----	
N° piastre <i>Nr. of plates</i>	Codice generico <i>General code</i>	Imballo singolo <i>Individual packaging</i>	Imballo 5 pz <i>5-piece packaging</i>
24	17B1902433	17S1902433	17M1902433

ZB 190

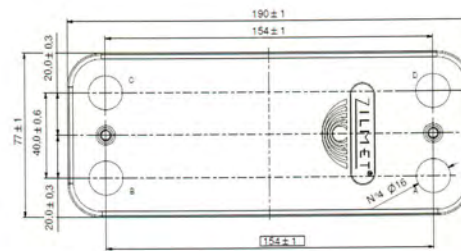

Applicazione tipo - <i>Typical application</i>		JUNKERS	
Tipo attacco - <i>Way of connection</i>		O-RING	
Caratteristiche - <i>Features</i>		Interasse fori - <i>Holes distance</i> : 154 x 40 mm Interasse prigionieri - <i>Studs distance</i> : 154 mm	
N° piastre <i>Nr. of plates</i>	Codice generico <i>General code</i>	Imballo singolo <i>Individual packaging</i>	Imballo 5 pz <i>5-piece packaging</i>
12	17B1901206	17S1901206	17M1901206



Scambiatori a piastre: tabella compatibilità
Heat exchangers: compatibility list



ZB 195

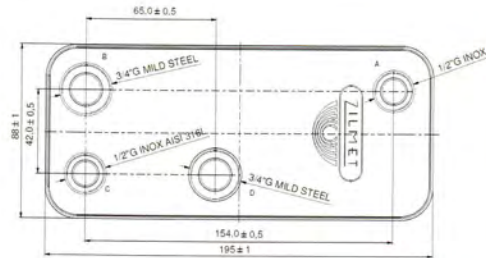

Applicazione tipo - *Typical application*

LAMBORGHINI

Tipo attacco - *Way of connection*

Filettato - *Threaded*

Caratteristiche - *Features*

Interasse fori - *Holes distance*: 154 x 42 mm
Raccordi - *Connections*: 2 x 3/4" + 2 x 1/2"

N° piastre <i>Nr. of plates</i>	Codice generico <i>General code</i>	Imballo singolo <i>Individual packaging</i>	Imballo 4 pz <i>4-piece packaging</i>
15	17B1951502	17S1951502	17M1951502
17	17B1951702	17S1951702	17M1951702
19	17B1951902	17S1951902	17M1951902

ZB 190

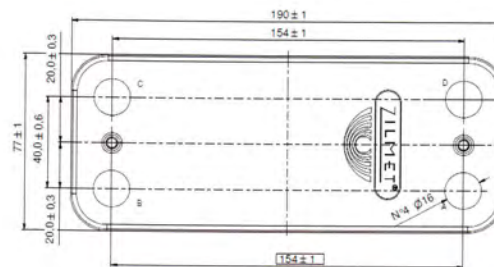

Applicazione tipo - *Typical application*

RADIANT

Tipo attacco - *Way of connection*

O-RING

Caratteristiche - *Features*

Interasse fori - *Holes distance*: 154 x 40 mm
Interasse prigionieri - *Studs distance*: 154 mm

N° piastre <i>Nr. of plates</i>	Codice generico <i>General code</i>	Imballo singolo <i>Individual packaging</i>	Imballo 5 pz <i>5-piece packaging</i>
14	17B1901406	17S1901406	17M1901406
16	17B1901606	17S1901606	17M1901606
20	17B1902006	17S1902006	17M1902006



Scambiatori a piastre: tabella compatibilità
Heat exchangers: compatibility list



ZB 207

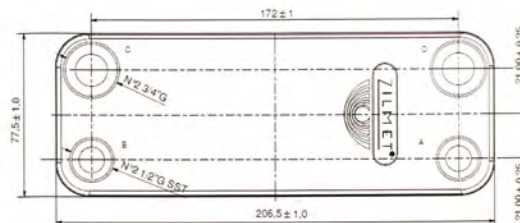

Applicazione tipo - Typical application		RAVENHEAT	
Tipo attacco - Way of connection		Filettato - Threaded	
Caratteristiche - Features		Interasse fori - Holes distance: 172 x 42 mm Raccordi - Connections: 2 x 3/4" + 2 x 1/2"	
N° piastre Nr. of plates	Codice generico General code	Imballo singolo Individual packaging	Imballo 5 pz 5-piece packaging
20	17B2072007	17S2072007	17M2072007

ZB 190

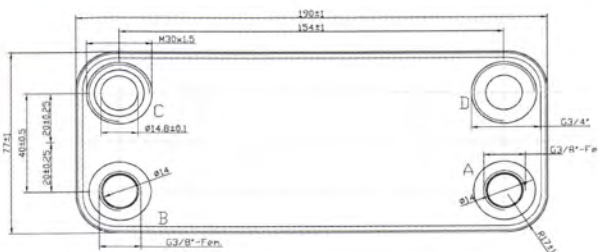

Applicazione tipo - Typical application		RIELLO	
Tipo attacco - Way of connection		Filettato - Threaded	
Caratteristiche - Features		Interasse fori - Holes distance: 154 x 40 mm Raccordi - Connections: 1 x 3/4" + 1 x 1/2" + 1 x 3/8" + 1 x M30	
N° piastre Nr. of plates	Codice generico General code	Imballo singolo Individual packaging	Imballo 5 pz 5-piece packaging
12	17B1901208	17S1901208	17M1901208
14	17B1901408	17S1901408	17M1901408
16	17B1901608	17S1901608	17M1901608



Scambiatori a piastre: tabella compatibilità
Heat exchangers: compatibility list



ZB 207

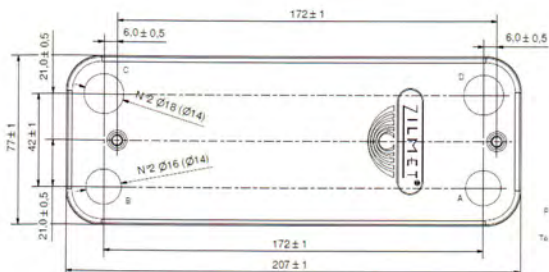

Applicazione tipo - *Typical application*

SAUNIER DUVAL

Tipo attacco - *Way of connection*

O-RING

Caratteristiche - *Features*

Interasse fori - *Holes distance*: 172 x 42 mm
Interasse prigionieri - *Studs distance*: 172 mm

N° piastre <i>Nr. of plates</i>	Codice generico <i>General code</i>	Imballo singolo <i>Individual packaging</i>	Imballo 5 pz <i>5-piece packaging</i>
12	17B2071213	17S2071213	17M2071213
16	17B2071613	17S2071613	17M2071613

ZB 195

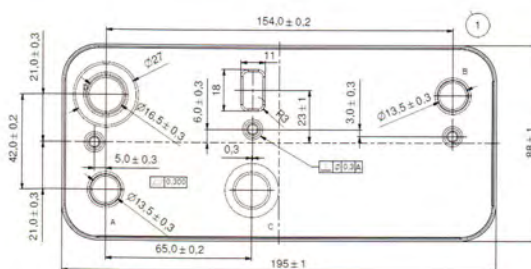

Applicazione tipo - *Typical application*

SILE

Tipo attacco - *Way of connection*

O-RING

Caratteristiche - *Features*

Interasse fori - *Holes distance*: 154 x 42 mm
Interasse prigionieri - *Studs distance*: 159 / 65 mm

N° piastre <i>Nr. of plates</i>	Codice generico <i>General code</i>	Imballo singolo <i>Individual packaging</i>	Imballo 4 pz <i>4-piece packaging</i>
17	17B1951721	17S1951721	17M1951721



Scambiatori a piastre: tabella compatibilità
Heat exchangers: compatibility list



ZB 195

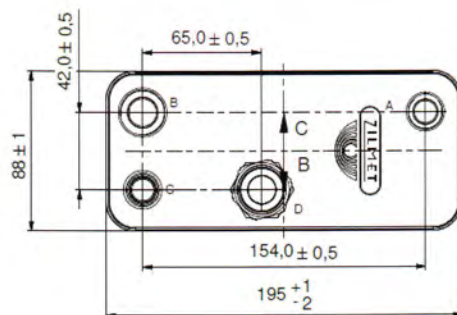

Applicazione tipo - <i>Typical application</i>		SILE	
Tipo attacco - <i>Way of connection</i>		Filettato - <i>Threaded</i>	
Caratteristiche - <i>Features</i>		Interasse fori - <i>Holes distance</i> : 154 x 42 mm Raccordi - <i>Connections</i> : 2 x 3/4" + 1 x 1/2" + 1 quick c.	
N° piastre <i>Nr. of plates</i>	Codice generico <i>General code</i>	Imballo singolo <i>Individual packaging</i>	Imballo 4 pz <i>4-piece packaging</i>
15	17B1951501	17S1951501	17M1951501

ZB 207

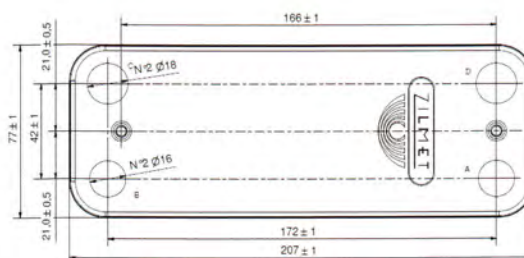

Applicazione tipo - <i>Typical application</i>		TURK DEMIR DOKUM	
Tipo attacco - <i>Way of connection</i>		O-RING	
Caratteristiche - <i>Features</i>		Interasse fori - <i>Holes distance</i> : 172 x 42 mm Interasse prigionieri - <i>Studs distance</i> : 166 mm	
N° piastre <i>Nr. of plates</i>	Codice generico <i>General code</i>	Imballo singolo <i>Individual packaging</i>	Imballo 5 pz <i>5-piece packaging</i>
10	17T2071006	17ST071006	17MT071006
12	17T2071206	17ST071206	17MT071206
14	17T2071406	17ST071406	17MT071406



Scambiatori a piastre: tabella compatibilità
Heat exchangers: compatibility list



ZB 190



Applicazione tipo - *Typical application*

UNICAL

Tipo attacco - *Way of connection*

O-RING

Caratteristiche - *Features*

Interasse fori - *Holes distance*: 154 x 40 mm
Interasse prigionieri - *Studs distance*: 154 mm

N° piastre <i>Nr. of plates</i>	Codice generico <i>General code</i>	Imballo singolo <i>Individual packaging</i>	Imballo 5 pz <i>5-piece packaging</i>
16	17B1901621	17S1901621	17M1901621
20	17B1902021	17S1902021	17M1902021
24	17B1902421	17S1902421	17M1902421

ZB 207

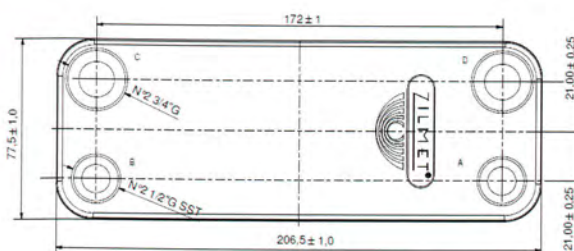

Applicazione tipo - *Typical application*

UNICAL

Tipo attacco - *Way of connection*

Filettato - *Threaded*

Caratteristiche - *Features*

Interasse fori - *Holes distance*: 172 x 42 mm
Raccordi - *Connections*: 2 x 3/4" + 2 x 1/2"

N° piastre <i>Nr. of plates</i>	Codice generico <i>General code</i>	Imballo singolo <i>Individual packaging</i>	Imballo 5 pz <i>5-piece packaging</i>
14	17B2071407	17S2071407	17M2071407



Scambiatori a piastre: tabella compatibilità
Heat exchangers: compatibility list



ZB 190

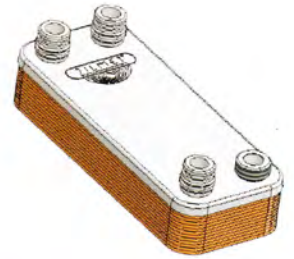
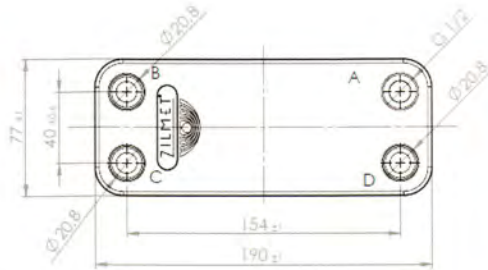

Applicazione tipo - Typical application		VAILLANT	
Tipo attacco - Way of connection		Innesto - Quick connection	
Caratteristiche - Features		Interasse fori - Holes distance: 154 x 40 mm Raccordi - Connections: 1 x 1/2" + 3 x quick	
N° piastre Nr. of plates	Codice generico General code	Imballo singolo Individual packaging	Imballo 5 pz 5-piece packaging
12	17B1901215	17S1901215	17M1901215
14	17B1901415	17S1901415	17M1901415
20	17B1902015	17S1902015	17M1902015

ZB 207

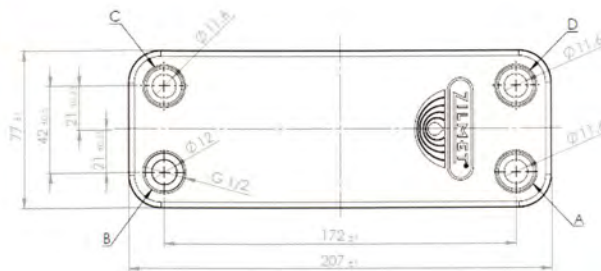

Applicazione tipo - Typical application		VAILLANT	
Tipo attacco - Way of connection		Innesto - Quick connection	
Caratteristiche - Features		Interasse fori - Holes distance: 172 x 42 mm Raccordi - Connections: 1 x 1/2" + 3 x quick	
N° piastre Nr. of plates	Codice generico General code	Imballo singolo Individual packaging	Imballo 5 pz 5-piece packaging
12	17B2071220	17S2071220	17M2071220



Scambiatori a piastre: tabella compatibilità
Heat exchangers: compatibility list



ZB 207

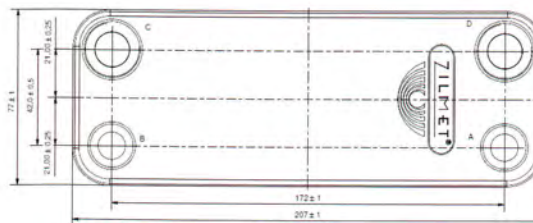

Applicazione tipo - <i>Typical application</i>		VAILLANT	
Tipo attacco - <i>Way of connection</i>		Filettato - <i>Threaded</i>	
Caratteristiche - <i>Features</i>		Interasse fori - <i>Holes distance</i> : 172 x 42 mm Raccordi - <i>Connections</i> : 2 x 3/4" + 2 x 1/2"	
N° piastre <i>Nr. of plates</i>	Codice generico <i>General code</i>	Imballo singolo <i>Individual packaging</i>	Imballo 5 pz <i>5-piece packaging</i>
14	17B2071416	17S2071416	17M2071416

ZB 207

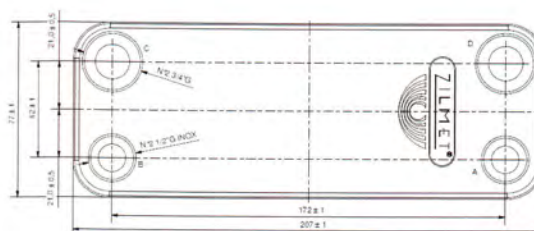

Applicazione tipo - <i>Typical application</i>		VAILLANT	
Tipo attacco - <i>Way of connection</i>		Filettato - <i>Threaded</i>	
Caratteristiche - <i>Features</i>		Interasse fori - <i>Holes distance</i> : 172 x 42 mm Raccordi - <i>Connections</i> : 2 x 1/2" + 2 x 3/4"	
N° piastre <i>Nr. of plates</i>	Codice generico <i>General code</i>	Imballo singolo <i>Individual packaging</i>	Imballo 5 pz <i>5-piece packaging</i>
14	17B2071402	17S2071402	17M2071402



Scambiatori a piastre: tabella compatibilità
Heat exchangers: compatibility list



ZB 207

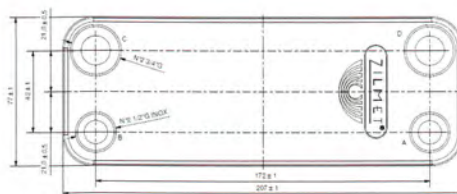

Applicazione tipo - Typical application		VAILLANT
Tipo attacco - Way of connection		Filettato - Threaded
Caratteristiche - Features		Interasse fori - Holes distance: 172 x 42 mm Raccordi - Connections: 2 x 3/4" + 2 x 1/2"
N° piastre Nr. of plates	Codice generico General code	Imballo singolo Individual packaging 
14	17B2071493	17S2071493



Scambiatori a piastre: tabella compatibilità
Heat exchangers: compatibility list